

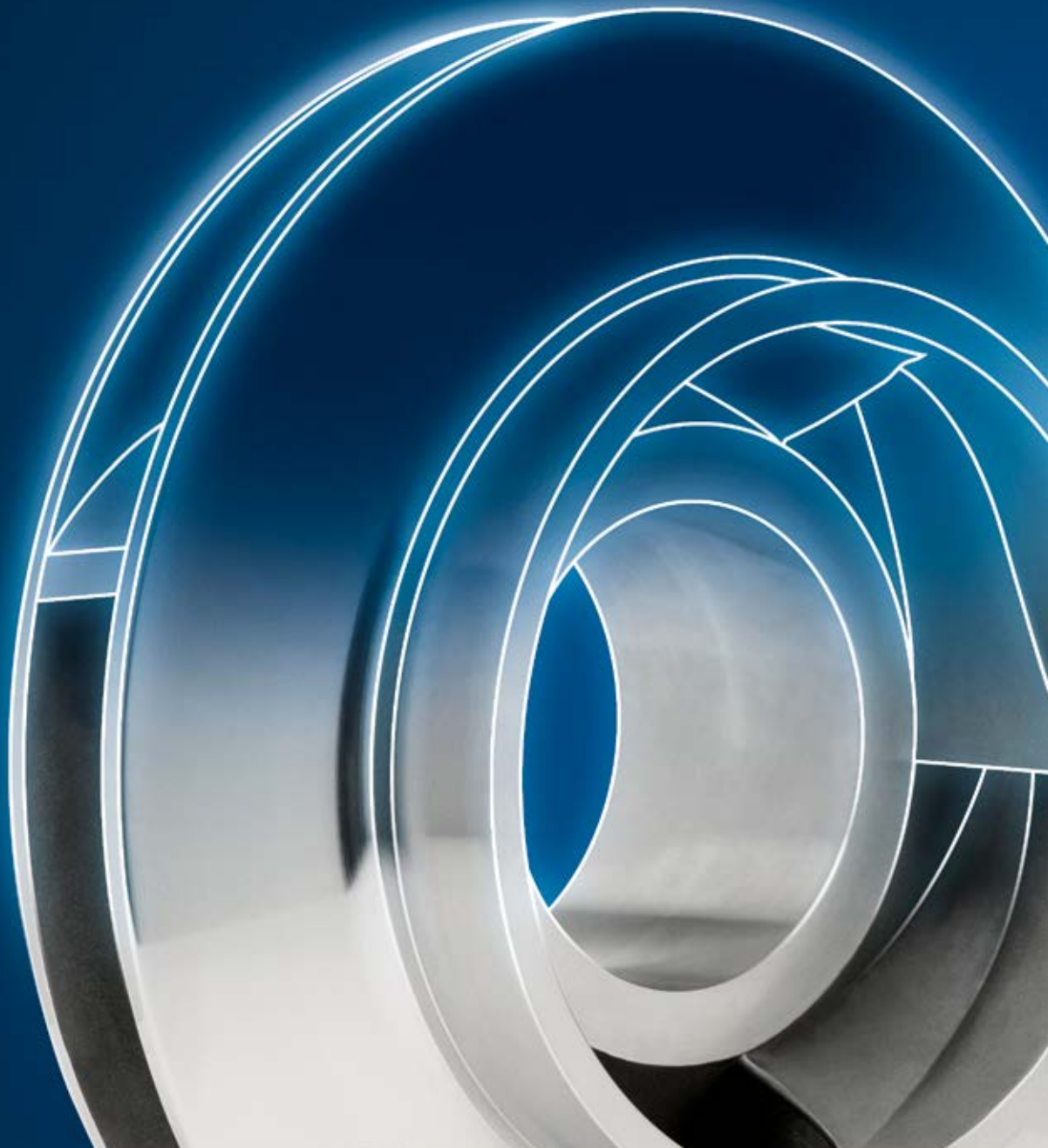

KSB Group



Annual Report 2017





KSB Profile: KSB is a leading supplier of pumps, valves and related support services. Our reliable, high-efficiency products are used in applications worldwide where fluids need to be transported or shut off, covering everything from building services, industry and water transport to waste water treatment, power plant processes and mining. Wherever our customers are in the world, 170 service centres are on hand to provide local inspection, servicing, maintenance and repair services. Innovative technology that is the fruit of KSB's research and development activities forms the basis for the company's success and that of our customers.

Cover:

Pump impellers can be reconstructed and reproduced using reverse engineering.

GROUP FINANCIAL HIGHLIGHTS

BUSINESS DEVELOPMENT AND EARNINGS

		2017	2016	2015	2014	2013
Order intake	€ m	2,265.3	2,156.6	2,261.2	2,321.2	2,241.2
Sales revenue	€ m	2,205.0	2,165.7	2,334.8	2,181.7	2,247.3
Earnings before interest and taxes (EBIT)	€ m	117.2	88.2	105.2	89.2*	136.2
Earnings before income taxes (EBT)	€ m	104.2	74.6	93.4	72.8*	119.4
Earnings after income taxes	€ m	52.1	47.8	52.2	46.3*	79.9
Cash flow	€ m	124.4	139.8	137.5	124.4*	142.3

BALANCE SHEET

		2017	2016	2015	2014	2013
Balance sheet total	€ m	2,253.4	2,350.2	2,291.1	2,277.9*	2,151.5
Fixed assets	€ m	642.6	641.2	633.1	622.6	591.2
Capital expenditure	€ m	101.9	82.2	82.8	85.1	57.1
Depreciation and amortisation expense	€ m	70.6	72.6	72.8	66.2	60.2
Current assets	€ m	1,519.1	1,596.9	1,573.6	1,568.5	1,520.6
Equity (incl. non-controlling interests)	€ m	885.4	890.3	870.2	819.7*	844.5
Equity ratio (incl. non-controlling interests)	%	39.3	37.9	38.0	36.0*	39.3

PROFITABILITY

		2017	2016	2015	2014	2013
Return on sales	%	4.7	3.5	4.0	3.3	5.3
Return on equity	%	11.7	8.5	11.1	8.8*	14.2
Return on capital employed	%	5.4	4.1	4.9	4.3	6.6

EMPLOYEES

		2017	2016	2015	2014	2013
Number of employees at 31 Dec.		15,455	15,572	16,196	16,309	16,546
Staff costs	€ m	796.7	798.8	819.3	784.8*	787.6

SHARES

		2017	2016	2015	2014	2013
Market capitalisation at 31 Dec.	€ m	884.4	637.7	659.2	735.7	804.3
Earnings per ordinary share (EPS)	€	21.10	18.68	22.30	21.97*	37.38
Earnings per preference share (EPS)	€	21.36	18.94	22.56	22.23*	37.64
Dividend per ordinary share	€	7.50	5.50	5.50	8.50	12.00
Dividend per preference share	€	7.76	5.76	5.76	8.76	12.26

* Adjustment under IAS 8

PRODUCTS AND SERVICES

KSB pumps and valves are primarily used to transport or shut off all kinds of fluid. Their efficient and reliable operation is taken care of by 3,000 service specialists worldwide offering inspection, servicing, maintenance, repair and consultancy services. The most important fields of application for our products are:

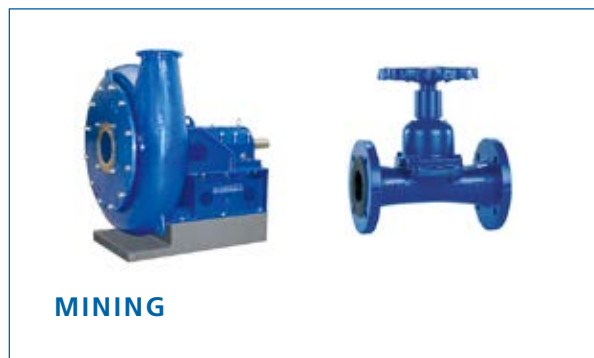
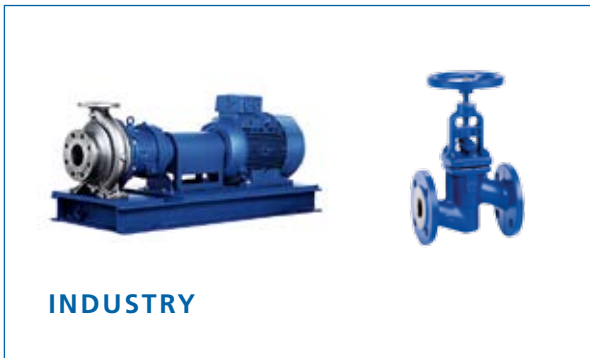

Digital Transformation

As one of the world's leading suppliers of pumps, valves and related support services, KSB is a pioneer in top-tier technology. And the expertise of our highly qualified employees makes this the foundation for our success. To improve the efficiency, performance and reliability of our pumps and valves in industry and energy generation, water and waste water, building services and mining applications, KSB has expanded its research and development work and embraced digital technologies. These enable us to continually enhance our products and services, paving the way for KSB's profitable and sustainable growth.

1

MANAGEMENT AND ISSUES 2017

4	Management
6	To Our Shareholders
8	Report of the Supervisory Board
18	A Look Back at 2017
20	Corporate Social Responsibility (Combined Separate Non-financial Report)

2

DIGITAL TRANSFORMATION

32	Overview
34	KSB Cloud
38	MyFlow Drive
42	Digital Life Cycle Log
46	Additive Manufacturing
50	Reverse Engineering

3

GROUP MANAGEMENT REPORT

56	Basic Principles of the Group
56	Group Business Model
58	Control System
58	Research and Development
59	Economic Review
59	Macroeconomic Environment and Sector View
60	Business Development and Results of Operations
64	Financial Position and Net Assets
68	Summary of the Performance in the Financial Year
68	Dependent Company Report
69	Report on Expected Developments
72	Opportunities and Risks Report
84	Acquisition-related Disclosures
86	Corporate Governance Statement (Section 315d of the HGB in Conjunction with Section 289f of the HGB)
87	Statement on the Non-financial Report (Sections 315b, 315c in Conjunction with Sections 289b to 289e of the HGB)
88	Remuneration of the Board of Management

4

CONSOLIDATED FINANCIAL STATEMENTS

92	Balance Sheet
93	Statement of Comprehensive Income
94	Statement of Changes in Equity
96	Statement of Cash Flows
97	Notes
154	List of Shareholdings
158	Supervisory Board
160	Legal Representatives
161	Proposal on the Appropriation of the Net Retained Earnings of KSB SE & Co. KGaA

5

GENERAL INFORMATION

164	Responsibility Statement
165	Independent Auditor's Report
175	Glossary
176	Contacts

COVER

Group Financial Highlights
Products and Services
Global Presence
Financial Calendar

LEGEND

 Glossary
→ Reference to table

1

MANAGEMENT AND ISSUES 2017

- 4 Management
- 6 To Our Shareholders
- 8 Report of the Supervisory Board
- 18 A Look Back at 2017
- 20 Corporate Social Responsibility
(Combined Separate Non-financial Report)

MANAGEMENT



Dr. Stephan Timmermann

took over as the Chairman of the Board of Management of KSB AG on 13 November 2017. Since 17 January 2018 he has been a Managing Director and CEO of KSB Management SE. His areas of responsibility include Strategy, Human Resources, Communications, and Legal and Compliance.

Ralf Kannefuss

has been responsible for Sales and Service since 1 July 2017. Having initially taken charge of these areas as a member of the Board of Management of KSB AG, he is now assigned this responsibility as a Managing Director of KSB Management SE.

**Dr. Stephan Bross**

has been responsible for Technology as well as the Corporate Unit Pumps and Corporate Unit Valves since 15 September 2017, initially as a member of the Board of Management of KSB AG and since 17 January 2018 as a Managing Director of KSB Management SE. In 2018, he also took on responsibility for Global Operations.

Dr. Matthias Schmitz

was assigned responsibility for Controlling/ Finance, Information Technology and Global Procurement as a member of the Board of Management of KSB AG on 1 June 2017. Since 17 January 2018 he has been in charge of these areas as a Managing Director of KSB Management SE.



Dr. Stephan Timmermann

Dear Shareholders and Business Partners,

As a global company, we operate in a market environment that can change dramatically overnight due to political or social events. At the same time we are facing developments that may be less sudden, but will nevertheless have radical consequences for the economy and working life.

For a mechanical engineering company like KSB, it is above all the rapid change in technology that calls for new solutions in research and development. The ongoing trend towards globalisation is also putting traditional production concepts into question. Similarly, the rapid rise of some emerging markets is changing the economic areas we serve, which is something we have to adapt to in terms of sales and service. Finally, demographic trends make it necessary for us to adjust our work and life models in relation to age. For this purpose, we are developing regionally differentiated concepts, including qualification and development programmes.

People shape our brand

To change KSB in a positive way, and thus make it better and well-equipped for the future, is a task we are focusing on. In doing so, we can rely on the readiness to learn, creativity and commitment of our employees. With their work they represent what the KSB brand stands for. And it is they who keep our brand promise every day: Technology that drives success. Wherever they do more for their customers than others, they lay the foundation for future success.

To lead our staff through the present changes, to develop their professional skills so they can meet new requirements, and to provide an inspiring work environment for them – these are the tasks which we, as the company's management, are dedicated to achieving in an effective manner.

Digitalisation generates ideas

Currently we are succeeding particularly well in this with our Business Innovation Lab, where KSB staff collaborate with external specialists and students, and which won an award in 2017. An unconventional approach to thinking and working helps us adapt to digital change and overcome the boundaries between mechanical engineering and information technology.

Linking together these fields of technology creates space for innovations which lead to new products, services and business models. From 3D printing to cloud-based service solutions, our aim is to be a pioneer in the industry.

Growth opens up new avenues

Change requires ideas, performance, and the will to make the most of both. It also requires financial resources to bring promising concepts to a successful conclusion. We achieve this through profitable growth and a sustainable ownership structure. Both of these give us the necessary freedom to act.

In 2017 we made good progress with a leap in profits of almost 40 %. Our order intake rose by 5.0 % and sales revenue will follow this development in due course. In addition, a comfortable net financial position provides us with sufficient leeway to do all that is needed to help our customers, motivate our employees and secure our future.

A new structure creates a new basis

From an organisational point of view, we are also on the road to change. In mid-January KSB AG converted into a KGaA, a partnership limited by shares. This follows a resolution passed at last year's Annual General Meeting. With this change in legal form, we have opened up new financial and strategic options for our company, as well as providing a solid basis.

The operative business of the new KSB SE & Co. KGaA will be managed by my three colleagues on the former Board of Management and myself as Managing Directors of a newly founded management company. In this KSB Management SE, we rely on the advice and experience of a five-member Administrative Board. It is formally the highest management body of the KGaA.

As shareholders, you have automatically become limited partners of the KGaA. Apart from this your status and rights at the Annual General Meeting remain largely unchanged. One exception is the discontinuation of the Supervisory Board's personnel decision-making competence: The new organisation with four Managing Directors no longer has a board of management to be elected by this monitoring body.

In the present configuration we will work intensively with the Administrative Board and the Supervisory Board to continually improve both the competitiveness and profitability of the company. We feel that we are currently on the right track here. We will be glad if you, as shareholders or business partners, continue with us on the road ahead.



Dr. Stephan Timmermann, CEO

REPORT OF THE SUPERVISORY BOARD

The 2017 financial year was dominated by personnel and structural changes, including the change in legal form of KSB Aktiengesellschaft to a partnership limited by shares [*Kommanditgesellschaft auf Aktien*] by resolution of the Annual General Meeting on 10 May 2017, which was successfully completed by entry in the *Handelsregister* [German Commercial Register] on 17 January 2018. Under section 203, sentence 1 of the *UmwG* [*Umwandlungsgesetz* – German Transformation Act], the members of the Supervisory Board of KSB Aktiengesellschaft became members of the Supervisory Board of KSB SE & Co. KGaA for the rest of their term in office. By contrast, a *Kommanditgesellschaft auf Aktien* (KGaA) has no Board of Management; the latter's tasks have been performed by the general partner of the company, KSB Management SE, Frankenthal, since the change in legal form came into effect. This company is represented by Managing Directors, with the previous members of the Board of Management of KSB AG having been appointed to these positions. For the 2017 financial year and the subsequent period until 17 January 2018, this report is based on the former structure of a public limited company under German law [*Aktiengesellschaft*] with the Board of Management as the management and representative body. Where periods after 17 January 2018 are discussed herein, this report refers to the new legal form of a KGaA.

Throughout the last financial year, the Supervisory Board continued to perform its tasks with great care in accordance with the law, the Articles of Association and the Rules of Procedure. We regularly advised the Board of Management on corporate management issues and monitored its work. The Supervisory Board was consulted directly and at an early stage with regard to decisions of fundamental importance. The Board of Management informed us in a comprehensive and timely manner, and in compliance with its duty to inform under the law and Rules of Procedure, about the position of the company, in particular its business, financial and staffing situation, planned investments, as well as relevant corporate planning and strategic and organisational development issues via written and oral reports prepared regularly and on an ad hoc basis. As in the past, we continued to meet on a regular basis to discuss selected issues in the absence of the Board of Management.

We discussed all business transactions significant for the company in detail on the basis of the Board of Management's reports. Any departures in business developments from the plans and targets were reviewed and commented on in detail by the Board of Management. We adopted our resolutions on the reports and proposals by the Board of Management after thorough examination and discussion. Beyond the intensive work in the plenary sessions and in the committees, the Chairman of the Supervisory Board in particular and other Supervisory Board members were in frequent contact with the Board of Management outside the meetings to discuss the current business development and significant transactions as well as questions of strategy, planning, risk assessment, risk management and compliance.

Conflicts of interest of the Supervisory Board members Klaus Kühborth and Monika Kühborth within the framework of the below discussion of relations covering the supply of services of KSB AG to its majority shareholder, Johannes und Jacob Klein GmbH (formerly Klein Pumpen

GmbH), as well as to other related parties, were disclosed to the Supervisory Board; both did not participate in the taking of resolutions on this subject area. In the reporting period, no other conflicts of interest arose involving members of the Board of Management and Supervisory Board that would have been subject to disclosure in the Report of the Supervisory Board.

MAIN FOCUS OF WORK IN THE SUPERVISORY BOARD PLENARY SESSIONS

Key topics of our consultations with the Board of Management were the revision of strategic objectives, the monitoring of the roll-out of a shared services organisation decided on in 2016 and the continued development of the corporate organisation, including the appointment of four new members to the Board of Management with a view to the change in legal form implemented early in 2018. The analysis of business development in the segments and Regions represented an additional focus, as did major investment projects at various sites. We dealt on an ongoing basis with the company's economic position, the progress of the new efficiency improvement programme, and the prospects facing selected markets. Based on the recommendations and suggestions contained in the German Corporate Governance Code, we also looked at fundamental aspects of good corporate governance. Special emphasis was placed on corporate culture as KSB again recorded and evaluated employees' views concerning the company by means of an international spot check.

In 2017 four regular Supervisory Board meetings and a constituent meeting were held; the committee also met three times to discuss special topics. The performance of KSB Aktiengesellschaft and the Group was the subject of regular discussions, primarily with regard to net assets, financial position, employment levels and strategic direction, as well as material investment, divestment and acquisition projects.

The Board of Management regularly explained to us in detail the ways in which KSB can achieve the planned growth for the coming years, including the underlying methodological and strategic considerations. Required investments were subjected to critical analysis before being approved and their implementation was subsequently monitored by us. In this context, the Supervisory Board approved significant financial resources to maintain the high technical level of plants on a Group-wide basis, while at the same time taking into account specific site-related aspects. We also repeatedly dealt with the status of the comprehensive investments that were initiated in recent years. For instance, we convinced ourselves that, in particular, the expansion work in our French and our Indian subsidiary is making good progress at the sites in La Roche-Chalais and Shirwal. The fundamental upgrade of the Pakistani foundry and the construction of our new building in Moscow were largely completed. The latter will serve both administrative and production purposes, and we thereby aim to strengthen the close business relationships with Russia and in the neighbouring states. As reported in previous years, considerable technically demanding preparations were required to win a major Chinese order

for the delivery of pumps. We expect the successful implementation of this ambitious project, whose completion is scheduled for 2018, to strengthen KSB's market position over the long term. We therefore had the Board of Management continuously update us on the status of order processing. Where the start or expansion of business activities led to property acquisitions, we discussed the long-term impact of such measures.

In the light of the ongoing change of requirements to be met by an efficient corporate structure, we completed the discussion about the transformation of KSB AG. To align the company with the future requirements of capital markets and to secure its independence over the long term, the Supervisory Board decided at the start of 2017 to prepare the conversion of KSB AG into a – still stock exchange-listed – partnership limited by shares. After obtaining approval from the Annual General Meeting in May 2017, this was implemented by entry in the German Commercial Register on 17 January 2018.

We also used the past financial year for a fundamental redesign of corporate management. Following the proposal of the Personnel Committee in each case, four new members of the Board of Management were appointed, including Dr. Stephan J. Timmermann as the Chairman [*Sprecher*] of the Board of Management. With Dr. Peter Buthmann's departure as of the end of 2017 following his retirement, we completed the reshuffle. We see major potential for our business in the opportunities provided by a stronger focus on certain areas of responsibility. In the course of the change in the legal form of KSB, the members of the Board of Management were appointed Managing Directors of the general partner.

Repeatedly on the agenda was the continued development of other aspects of the corporate organisation. We devoted particular attention to the reduction in internal administrative expenses, for instance by monitoring the programme kicked off at the end of 2015 by the Board of Management to improve efficiency in all Group areas, which also includes reducing the number of Group companies. Against this background, the outsourcing of standardised processes to external services providers (shared services) was also of great importance. With this ambitious project, KSB aims to further standardise internal processes, in particular in the commercial areas, and optimise cost structures permanently in the future. Some adjustment requirements became apparent upon the start of the implementation of this demanding project; we discussed them in detail with the Board of Management. Another focus of our deliberations continued to be the progress made towards strengthening our value-based corporate culture, with the Board of Management providing regular updates. Both interesting findings and new needs for action emerged from a spot check employee engagement survey as a follow-

up process to the broadly designed 2016 survey. These have to be addressed in order to continue the constructive dialogue with staff and meet their expectations. By doing this we ensure that the employees' willingness to perform and engagement are continually strengthened.

We also considered the relations covering the supply of services of KSB AG to its majority shareholder and other related parties in the year under review. After initial indications that individual services to related parties may no longer have been provided on an arm's length basis or may have been settled either incorrectly or not at all in the past, the Supervisory Board, together with the Board of Management, commissioned auditing and tax consultancy firms as well as a law firm with a comprehensive independent examination of the facts along with the resulting consequences. The Chairman of the Audit Committee reported regularly on the status of this matter.

For the September session, the Supervisory Board convened for a meeting at the Lille site in France. On this occasion, we discussed in detail with the Board of Management its considerations on the realignment of the individual Board of Management portfolios. Within the scope of compliance with the non-financial reporting requirements imposed by law we commissioned the auditors to review this report. The local management informed us of the opportunities and risks of the French market. In addition, we visited the modern technical facilities at the plant.

At the two sessions in November and December, a focus was on the general economic development in China and the consequences this may have on the organisation of KSB's business in this important market. We also looked at business performance during the financial year and, in particular, at planning for 2018.

MAIN FOCUS OF WORK IN THE COMMITTEES

In order to perform its duties efficiently, the Supervisory Board worked with five committees in 2017. These prepare the Supervisory Board's resolutions and the special topics to be discussed in the plenary sessions. In addition, they also make their own decisions – to the extent that this is legally permissible – within the scope of their areas of responsibility. This allocation has proved worthwhile in practice. The Chairs of the committees regularly and comprehensively report in the plenary sessions on the content and results of the work carried out in the committees.

COMMITTEES OF THE SUPERVISORY BOARD

and their Chairs, as well as number of meetings in the year under review

CORPORATE DEVELOPMENT COMMITTEE

Until 28 February 2017
 Dr. Martin Auer
 From 23 March 2017
 Oswald Bubel
 No. of meetings: 4

NOMINATION COMMITTEE

Until 28 February 2017
 Dr. Thomas Seeberg
 From 23 March 2017
 Dr. Bernd Flohr
 No. of meetings: 3

PERSONNEL COMMITTEE

Until 28 February 2017
 Dr. Thomas Seeberg
 From 23 March 2017
 Dr. Bernd Flohr
 No. of meetings: 9

AUDIT COMMITTEE

Until 14 April 2017
 Dr. Jörg Matthias Großmann
 From 15 April 2017
 Klaus Burchards
 No. of meetings: 7

MEDIATION COMMITTEE

Until 28 February 2017
 Dr. Thomas Seeberg
 From 23 March 2017
 Dr. Bernd Flohr
 No. of meetings: 0

The **Nomination Committee** prepared proposals for the appointment of shareholder representatives to the Supervisory Board, in particular the Supervisory Board's nominations for the election of Supervisory Board members by the Annual General Meeting on 10 May 2017. It convened three times in the year under review. In looking for and evaluating suitable candidates with the requisite expertise and experience of the industry, long-term succession planning is a key factor.

The **Corporate Development Committee** deals with the company's strategic development, as well as with annual planning and finance, and technology issues. At four meetings in the year under review, it discussed in particular the areas of strategy controlling, production management and innovation, and – on an ongoing basis – looked at a number of major investments, which require the approval of the Supervisory Board. The development of certain business types, including but not limited to the general and project businesses, also figured on the agenda, as did tie-in measures during acquisitions and selected projects. The Committee looked in detail at the optimisation of production capacities within our international manufacturing network and the progress of global production integration. Another focus was on the opportunities offered by digitalisation, which need to be closely observed and harnessed. In addition to members of the Board of Management, the Heads of the relevant specialist departments also regularly took part in the committee meetings.

The **Personnel Committee** held nine meetings in the year under review. It primarily addresses personnel decisions as well as topics relating to the Board of Management's remuneration, including the terms of the individual service contracts, as well as other Board of Management issues. Decisions on the appointment and remuneration of members of the Board of Management were made in plenary session, with the committee acting in a preparatory capacity in each case. In the year under review, the Committee also discussed staff development issues with the aim of ensuring that any need for action in terms of filling Board of Management positions and positions at the management level directly below the Board is identified at an early stage and followed up. Not least, the Committee is promoting the internal developments within the company that aim at an increased proportion of women in leadership roles.

The main focus of deliberations in the financial year was the specific preparation of the personnel decisions for Board of Management positions. For instance, the Supervisory Board consented to the early resignation of Werner Stegmüller from the Board of Management – at his own request – effective 31 May 2017. As successor for the Finance portfolio and member of the Board of Management, the Supervisory Board appointed Dr. Matthias Schmitz on 22 March 2017, initially for a term of office of three years from 1 June 2017 to 31 May 2020. Ralf Kannefass was appointed on 9 May as the Board of Management member responsible for the Sales portfolio for a term of three years, from 1 July 2017 to 30 June 2020. The term of office of the long-standing member of the Board of Management and Human Resources Director, Dr. Peter Buthmann, was extended, for six months until the end of 2017, to ensure adequate continuity in the Board of Management. The Supervisory Board approved that the age limit applicable to members of the Board of Management was moderately exceeded. On 12 September 2017, Dr. Stephan Bross was appointed member of the Board of Management (Technology) for five years with effect from 15 September 2017 until 14 September 2022. Finally, the Supervisory Board appointed Dr. Stephan J. Timmermann as Chairman [*Sprecher*] of the Board of Management on 18 October 2017 from 13 November 2017 until 30 November 2020 and therefore for about three years; from 1 January 2018, Dr. Timmermann also assumed the role of Human Resources Director. All the above decisions were based on the proposals of the Personnel Committee.

The competencies of the committee changed with the coming into effect of the change in legal form. It now essentially decides on the approval of any internal transactions with KSB Management SE, its Administrative Board members and/or its Managing Directors, on the consent to other activities of these persons, the granting of loans to them and on any matters related to the remuneration of the Supervisory Board members.

The seven meetings of the **Audit Committee** in the year under review were always attended by a member of the Board of Management and, on several occasions, by the auditors and the Heads of relevant departments. The Committee discussed the 2016 annual and consolidated

financial statements, as well as the corresponding audit reports submitted by the auditors. The Audit Committee also prepared the independent examination by the Supervisory Board of the financial statements, the management reports and the proposal on the appropriation of the net retained earnings. In addition, the 2015 half-year financial report was discussed with the Board of Management. Moreover, the Committee presented a substantiated recommendation to the Supervisory Board for the election of the auditors at last year's Annual General Meeting. It then assigned to the auditors the audit of the annual and consolidated financial statements for the 2017 financial year and specified the key audit areas. The declaration of independence by the auditors was obtained in accordance with the recommendations of the German Corporate Governance Code (section 7.2.1), and the auditors' continued independence and performance of non-audit services were monitored. The Committee also focused on monitoring accounting, the accounting process, the risk management system – taking into account the relevant reports from Internal Audits – and the effectiveness of the internal control and auditing system, including compliance and the auditing of the annual financial statements. In this context, the committee members discussed in detail the supply of services to Johannes und Jacob Klein GmbH, as well as to other related parties. In the context of the clarification of facts and rectification, they also examined the measures taken by the Board of Management to obtain compensation for any disadvantages experienced by the company.

There was no requirement during the financial year under review to convene the **Mediation Committee** required by section 27(3) *MitbestG* [*Mitbestimmungsgesetz* – German Co-Determination Act]. It became obsolete with the coming into effect of the change in legal form.

CORPORATE GOVERNANCE AND STATEMENT OF COMPLIANCE

The Supervisory Board continuously monitored developments in corporate governance standards throughout the financial year. The Board of Management and the Supervisory Board have so far reported on corporate governance at KSB in accordance with section 3.10 of the German Corporate Governance Code as part of the Corporate Governance Statement pursuant to sections 289f(2 and 3) and 315d *HGB* [*Handelsgesetzbuch* – German Commercial Code]. On 12 September 2017 they issued a joint updated statement of compliance in accordance with section 161 of the *AktG* [*Aktiengesetz* – German Public Companies Act] and made it permanently available to shareholders on the company's web site. The general partner will now take the place of the Board of Management at KSB SE & Co. KGaA. KSB Aktiengesellschaft complied with the German Corporate Governance Code's recommendations subject to a few justified exceptions. The same applies to KSB SE & Co. KGaA, unless limited deviations from the Code arise from the change in legal form. On 21 March 2018, the Supervisory Board and the general partner, acting via its Managing Directors, issued a joint statement of compliance updated in this respect.

AUDIT OF THE 2017 ANNUAL AND CONSOLIDATED FINANCIAL STATEMENTS

The Supervisory Board examined the annual financial statements and the management report of KSB SE & Co. KGaA (formerly KSB AG) for the year ended 31 December 2017, which were prepared in accordance with the provisions of the *Handelsgesetzbuch (HGB)*, as well as the consolidated financial statements and the group management report for the year ended 31 December 2017, which were prepared in accordance with the International Financial Reporting Standards (IFRSs), and the proposal by the general partner on the appropriation of the net retained earnings. This also applies to the combined separate non-financial report of the company and the Group.

The accounting documentation, the proposal by the general partner on the appropriation of the net retained earnings, the non-financial reports and the audit reports submitted by the auditors were provided in good time to all members of the Supervisory Board. The documents were discussed in detail by the Audit Committee, in particular on 14 March 2018, as well as in the Supervisory Board plenary session on 21 March 2018 and explained in depth by the Managing Directors of the general partner. The auditors attended the meetings of both bodies, reported on the findings of the audit and were available to provide additional information.

The Mannheim office of PricewaterhouseCoopers GmbH Wirtschaftsprüfungsgesellschaft, Frankfurt, audited the annual financial statements and the management report of KSB SE & Co. KGaA (formerly KSB AG) for the year ended 31 December 2017, as well as the consolidated financial statements and the Group management report for the year ended 31 December 2017, and issued an unqualified opinion. The key audit areas defined for the auditors by the Audit Committee for the year under review mainly included the recognition of sales revenue based on the accrual principle of accounting and the recording and presentation of transactions with related parties. The non-financial reports were reviewed. The auditors reported on their findings on these key audit areas both orally and in writing.

The Supervisory Board concurs with the auditors' findings. Following the final result of the examination by the Audit Committee and its own review, the Supervisory Board raised no objections to the annual financial statements, consolidated financial statements, management report and Group management report, as well as the separate non-financial report of the company and the Group. In accordance with the recommendation of the Audit Committee, the Supervisory Board approved the annual financial statements prepared by the general partner. The proposal of the general partner on the appropriation of the net retained earnings of KSB SE & Co. KGaA, and in particular the increase in the dividend to EUR 7.50 per ordinary no-par-value share and EUR 7.76 per preference no-par-value share, is deemed to be appropriate by the Supervisory Board in accordance with its own review; it concurs with it.

DEPENDENT COMPANY REPORT

The auditors also audited the dependent company report for the 2017 financial year prepared by the general partner in accordance with section 312 of the *AktG* and issued the following unqualified audit opinion on this report:

“On completion of our audit and assessment in accordance with professional standards, we confirm that

1. The actual amounts and disclosures in the report are correct.
2. The consideration paid by the company for the transactions listed in the report was not inappropriately high, or disadvantages were compensated.”

The report of the general partner and the audit report were provided in good time to all members of the Supervisory Board and were also discussed by the Audit Committee and in plenary sessions. The auditors attended the meetings of both bodies, reported on the material findings of the audit and were available to provide additional information. The Supervisory Board concurs with the auditors’ findings. Both the recommendation by the Audit Committee and the final results of the Supervisory Board plenary session’s examination did not give rise to any objections to the dependent company report prepared by the general partner and to the statement by the general partner at the end of the dependent company report.

CHANGES TO THE BOARD OF MANAGEMENT AND SUPERVISORY BOARD

The changes to the Board of Management, i.e. the appointment of Dr. Stephan Bross, Ralf Kannefass, Dr. Matthias Schmitz and Dr. Stephan J. Timmermann as well as the departure of Werner Stegmüller and Dr. Peter Buthmann are described above in detail.

Dr. Martin Auer and Dr. Thomas Seeberg resigned from their office as members of the Supervisory Board as of 28 February in the reporting year, with Dr. Seeberg also stepping down from his position as Chairman of the Supervisory Board. Dr. Stella Ahlers and Dr. Jörg Matthias Großmann resigned from their office as members of the Supervisory Board with effect from the end of 20 March and 14 April 2017, respectively. Monika Kühborth, Oswald Bubel and Dr. Bernd Flohr were appointed members of the Supervisory Board by order of the *Amtsgericht Ludwigshafen am Rhein* [Local Court] on 21 March 2017 and Klaus Burchards by order of 18 April 2017, as successors for members who had stepped down. The Supervisory Board elected Dr. Flohr as its Chairman in the session of 22 March 2017. All new members were confirmed in their office by the Annual General Meeting on 10 May 2017, and Dr. Flohr

was re-elected as the Chairman of the Supervisory Board in the immediately following constituent Supervisory Board meeting. Due to his appointment as member of the Board of Management, Dr. Stephan Bross left the Supervisory Board with effect from 14 September 2017; Dr. Hans Stefan Wiß succeeded him as the elected replacement candidate. Monika Kühborth and Oswald Bubel resigned as members of the Supervisory Board as of the end of January 2018 in order to focus on their responsibilities at KSB Management SE. In their stead, Arturo Esquinca and Prof. Dr.-Ing. Corinna Salander were appointed members of the Supervisory Board by order of the *Amtsgericht Ludwigshafen am Rhein* dated 26 February 2018. The Supervisory Board would like to thank the members who have left the Board for their close cooperation. We also thank Dr. Seeberg for his prudent leadership.

The Supervisory Board would like to thank the Board of Management, the employees and employee representatives of all Group companies for their continued constructive and committed work during the past financial year.

Frankenthal, 21 March 2018

The Supervisory Board

A LOOK BACK AT 2017

Q1



KSB ZAMBIA

The South African holding company KSB Pumps S.A. (Pty) Ltd. acquires KSB Zambia Limited. Based in Kitwe, the company supplies pumping equipment for the mining industry and water applications.



BEREAVEMENT

Dr. Wolfgang Kühborth dies at the age of 92 on 31 January; many employees mourn his loss. A descendant of the Klein family, KSB's founders, Dr. Kühborth occupied various positions at KSB, playing a central role in the company's history for around 50 years.

USA

KSB divests the business activities of US company KSB AMRI, Inc. with effect from 31 January. Located in Houston, Texas, the company produces butterfly valves and actuators for the chemical industry. The sale is part of an initiative to streamline the Group's structure.

NEW PRESSURE BOOSTER SYSTEM

KSB showcases its new range of fully automatic pressure booster systems, KSB Delta Compact, at the ISH trade fair. The energy-efficient systems are designed for water supply applications in residential buildings, trade and industry. They ensure constant pressure even with fluctuating water consumption.



Q2



TRAINING

KSB is considered one of "Germany's top training companies 2017" according to a study commissioned by Deutschland Test and the Focus Money business magazine. The study evaluated the training quality of the 5,000 largest employers in a range of industries.



NEW FACTORY

After just ten months of construction work, KSB opens a modern factory in Shirwal, India, for producing pumps destined for power plants. Representing an investment of 40 million euros, the building fulfils high standards with regard to energy efficiency and environmental protection. It also provides the necessary space for modernising and expanding pump production. India is one of a group of countries with an underdeveloped energy supply infrastructure.

CHANGE IN LEGAL FORM

The Annual General Meeting adopts a resolution to convert KSB Aktiengesellschaft into a partnership limited by shares [*Kommanditgesellschaft auf Aktien – KGaA*]. From 2018, the company can trade under the name of KSB SE & Co. KGaA and will be led by a separate management company.



AWARD

KSB's Business Innovation Lab is crowned "Newcomer of the Year 2017" by the Capital business magazine. KSB specialists, external experts and students have been developing new business models at the think tank since the beginning of the year. Their mission is to facilitate KSB's digital transformation.



Q3



WASTE WATER PUMPS

KSB is awarded the contract to supply the pumping equipment for a large waste water treatment plant in Qatar. The plant is being built approximately 50 km north of the capital city, Doha. After it has been commissioned, the plant will treat around 56,000 cubic metres of waste water every day.

FORCES OF NATURE

A hurricane, earthquakes and heavy storms in August and September impact business operations at several of our smaller facilities in Texas, Mexico City and Zarautz in Spain. Emergency plans are initiated, highlighting the effectiveness of alternative work processes.

PUMPS FOR MEDINA

KSB supplies more than 100 pumps for a district cooling system designed to handle the air-conditioning of new hotel complexes which are being built in the Saudi Arabian pilgrimage city of Medina. The pumps are exclusively equipped with mechanical seals manufactured by KSB.

ONLINE ACCEPTANCE TESTING FOR PUMPS

KSB pioneers a world first by offering online acceptance testing in Halle, Pegnitz and Shanghai. While in the past customers had to attend acceptance testing on site, they can now remotely monitor the process in real time, saving them travel time and costs.



NEW BUTTERFLY VALVES

The new APORIS double-offset butterfly valve with elastomer sealing element extends KSB's product range. This valve is used for applications where customers need to transport water through pipelines under high pressures over long distances.



Q4



DIGITALISATION

October sees more than 2,500 KSB employees worldwide start working with the new Cloud for Customer (C4C) system to manage their customer data and respond more quickly to customers' needs. Sales and Service staff can access the information on their mobile devices any time, anywhere.



PUMP TEST STAND

A new pump test stand for standard pumps is commissioned in Frankenthal capable of testing approximately 3,000 pumps a year. Testing times are reduced by a third.

NEW MEMBERS OF THE BOARD OF MANAGEMENT

Dr. Stephan Timmermann joins the company as the Chairman of the Board of Management. Over the course of the year, the Supervisory Board has made four new appointments to the company's executive management body: Dr. Matthias Schmitz (Finance), Ralf Kannefuss (Sales and Service), Dr. Stephan Bross (Technology) and the new Chairman of the Board of Management.



PROTOTYPE

KSB completes the prototype for a compact, high-efficiency motor. By integrating the frequency inverter into the motor, developers have been able to reduce the unit volume by over 25 percent compared with the traditional design.



CORPORATE SOCIAL RESPONSIBILITY

COMBINED SEPARATE NON-FINANCIAL REPORT

The term “sustainability” is commonly used in a variety of ways. At KSB, we define sustainability as aligning our business with environmental, social and economic values. As well as responsible use of natural resources and the environment, it includes our responsibility towards our employees and our commitment to society. We present these issues in a separate combined non-financial report pursuant to sections 315b and 315c in conjunction with sections 289c to 289e of the HGB [*Handelsgesetzbuch* – German Commercial Code]. The report fulfils the requirements of the CSR Directive Implementation Act [*CSR-Richtlinie-Umsetzungsgesetz*] and combines the statement at company level with the Group statement outside of the management report.

The concepts outlined here apply to both the Group and to KSB AG (on 17 January 2018 the conversion into the new legal form KSB SE & Co. KGaA took legal effect); any instances where this is not the case are duly indicated. All information in the non-financial report relates to the former KSB AG in 2017. References to information not included in the group management report and any captions in this section represent supplementary information and are not part of the separate non-financial report. PricewaterhouseCoopers GmbH, Mannheim, performed a limited assurance engagement on the information in this report in accordance with ISAE 3000 (Revised) and issued an independent assurance report.

The concepts and activities outlined in this report follow the principles of the UN Global Compact² in the areas of human rights, labour standards, the environment and anti-corruption.

In accordance with our business model, we aim to supply customers worldwide with high-quality pumps and valves, as well as related support services. The vast majority of our products are developed in-house and are manufactured in factories on four continents. Our products are sold via our own sales organisation, supported by dealer networks composed of selected partners. KSB’s business model is presented in our group management report on page 56.

By signing the UN Global Compact in 2010, we committed ourselves to aligning our business activities with ten universal principles. But it is not only our managers and employees who endorse the principles of the Global Compact – our suppliers and business partners also share these commitments. We ask our strategically most important business partners whether and to what extent they use these or comparable standards as a source of orientation.

KSB’s sustainability principles are binding for all locations and companies of the KSB Group. These principles are set forth in our sustainability policy which applies to the entire Group. Our progress in these areas is regularly reviewed by a committee. Group management also receives a compliance report twice a year as well as an annual review of management issues relating to quality, the environment and occupational health and safety.

KSB operates a globally integrated management system in order to fulfil the same high standards worldwide with regard to quality, risk, environment, occupational health and safety, and sustainability. The management system is process-oriented and complies with the requirements of the international ISO 9001, ISO 14001, OHSAS 18001 and ISO 26000 standards as well as the UN Global Compact. It governs the organisational processes and workflows, responsibilities, procedures and processes at Group level and at our individual locations.

Percentage of renewable energy
in our power consumption:

33.3%

(KSB AG: 51.0 %)

Key sustainability topics for KSB

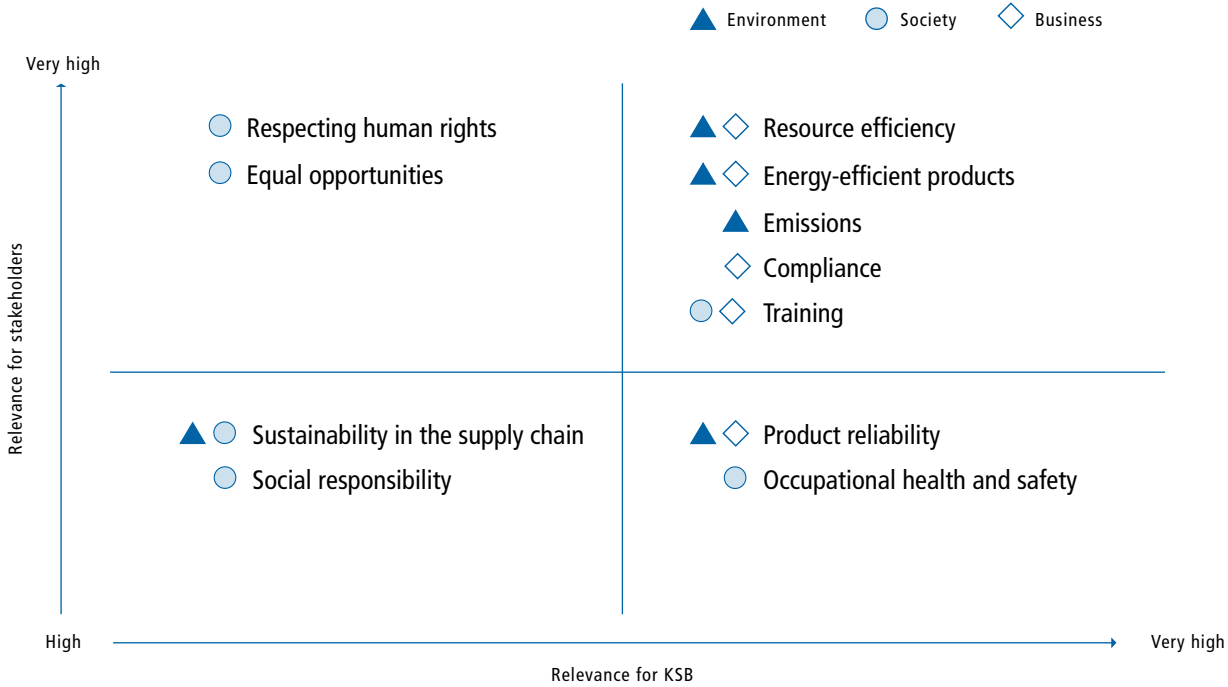

We continually assess the requirements and expectations of the various stakeholders with regard to our company. In 2016, we carried out an analysis of this for the first time in order to identify the key sustainability topics for KSB. Against the background of the new requirements defined in the HGB for non-financial reporting, the results were evaluated by the relevant specialist departments and our sustainability committee together with Group management in 2017. This enabled us to identify aspects and factors necessary for understanding the development and performance of the business and the position of the company as well as the impact of our activities on the following issues:

- Environment (resource efficiency, manufacturing of energy-efficient products, emissions and product safety)
- Combating corruption and bribery (compliance)
- Respecting human rights (sustainability in the supply chain)
- Employee concerns (training and development, equal opportunities, occupational health and safety)

These issues are directly related to our manufacturing activities, our products, our business partners and our employees. Our products also directly contribute towards protect-

ing the environment, for example, by saving energy or through their use in waste water treatment applications.

KSB's corporate responsibility also includes our commitment to society. In this section we report on our social engagement, including activities which do not have a direct or material impact on our business success.

KSB does not see any material risks, as assessed based on the net evaluation method, associated with our own business or the business relations of the company, its products and services which have or could have a serious negative impact on non-financial aspects, like the environment, anti-corruption, human rights, employee concerns and social issues. All other risks with an impact on our business activities are described in the group management report from page 75.

The non-financial report – unless otherwise stated – encompasses 28 key companies within the KSB Group. We have chosen these companies due to their impact in terms of aspects such as energy consumption and the percentage of employees involved. The 28 Group companies include all consolidated subsidiaries with production plants and two service companies with energy-intensive workshops.



Social commitment: In 2017, KSB supported an aid project to repair well pumps in Ivory Coast (large image), improving the drinking water supply for almost 2,000 Ivorians. Alongside measures to secure water supply, educational initiatives are central to KSB's social commitment.

To spark an interest in technology and science among young people, KSB regularly invites children and youngsters to its factories (small image) and supports projects run by the *Wissensfabrik – Unternehmen für Deutschland e.V.* [Knowledge Factory – Companies for Germany] initiative.



Financial aid: In India, KSB is regularly engaged in initiatives around its locations. These benefit socially disadvantaged children, the disabled, the elderly and the sick (upper image). As well as providing financial support, we also support facilities and organisations by donating technical equipment. In 2017, we financed multiple projects in Asia for supplying school facilities with water.

In Nepal (image on the left), this enabled two schools in Dakshinkali and Bhatapur to solve problems with water supply and sanitary facilities.

Energy consumption

	Total	KSB AG	Europe***	Asia / Pacific	Americas	Middle East / Africa
Total energy consumption*	273,750 MWh	94,868 MWh	141,900 MWh	38,258 MWh	80,432 MWh	13,160 MWh
Total electricity**	156,407 MWh	37,260 MWh	58,296 MWh	33,708 MWh	53,202 MWh	11,200 MWh
Electricity from renewables	52,064 MWh	18,989 MWh	23,629 MWh	5,712 MWh	19,908 MWh	2,815 MWh
CO ₂ emissions	97,248 t	22,072 t	31,042 t	29,916 t	28,871 t	7,418 t

* Electricity, gas, fuel oil, district heating, wood, etc.

** Total deviates due to rounding

*** Including KSB AG

ENVIRONMENT

As a manufacturing company, we strive to minimise our impact on the environment and to reduce energy consumption as far as possible. By pursuing this approach, we help to conserve natural resources and also increase the economic efficiency of our products in times of rising raw material prices. Furthermore, we avoid economic and legal risks which could potentially result from environmental damage and failure to comply with laws and regulations.

KSB follows the internationally recognised ISO 14001 [environmental management system](#) to ensure we deal responsibly with the natural environment. To date, we have established the environmental management system at 37 production and assembly locations (KSB AG: 3 locations), covering 90 percent of our production operations. As part of an evaluation process, we ask our strategically most important suppliers whether they comply with the requirements of applicable national or international environmental management standards. In 2017, we wrote to 1,058 of these suppliers, 537 of which responded. The proportion of these suppliers using recognised environmental standards as a source of orientation was 45 %.

In order to reduce energy consumption and CO₂ emissions, we conduct regular energy audits at our European locations. The resulting measures include the energy-efficient refurbishment of our buildings and foundries. To help cut electricity consumption, for example, we use high-efficiency lights and sensor-controlled lighting. We are also continually expanding our video conference system worldwide in

order to minimise the need to travel for our employees and to keep the associated costs and impact on the environment as low as possible.

We regularly record our energy consumption and CO₂ emissions so we can analyse this data. In the year under review, our energy consumption was 273,750 megawatt hours (KSB AG: 94,868 megawatt hours). With regard to energy consumption, 33.3 % (KSB AG: 51.0 %) of our energy came from renewable sources. We want to increase this percentage. In accordance with Scope 1 and Scope 2 of the GHG protocol [we calculated CO₂ emissions of 97,248 tonnes \(KSB AG: 22,072 tonnes\).](#)

Waste is produced during the manufacturing and transport of industrial products. KSB strives to keep waste levels as low as possible, returning materials to the material cycle wherever possible. For example, we collect paper and metal which is then sent for recycling.

We are reducing the volume of hazardous substances by progressively modernising our existing plants. If we discover any environmental pollution at our locations, we set aside provisions to meet the liabilities for the necessary clean-up work. In 2017, these provisions amounted to € 775,000 for KSB AG.

In order to minimise the impact of our business activities on the environment, we ensure that our manufacturing processes are as environmentally friendly as possible. We go even further than this by aiming to produce products that

Number of employees trained in compliance topics:

5,240

only require a small amount of electricity during their service life and that contribute towards preserving our environment.

Our energy-efficient products help reduce the amount of energy consumed by our customers. Our specialists adopt an integrated approach to optimising our customers' plants, analysing the entire hydraulic system and the complete life cycle of the plant. This enables us to ensure that all system components are perfectly matched.

Our declared goal is continual growth in the area of energy-efficient products. The benefits are three-fold: reducing the environmental impact caused by our customers, increasing our sales revenue and ensuring the future viability of our company. Digital transformation also plays a key role by helping us to identify potential energy savings in our customers' plants. In the year under review, we set up a Business Innovation Lab ² where we develop new business models to be implemented as part of the process of progressive digitalisation.

If products fail to meet a sufficient standard of quality, this could result in accidents and environmental pollution. We therefore attach great importance to the safety of our products. During the manufacturing process, we comply with recognised standards such as CE ² and established quality management systems. We are therefore able to design processes such that systematic errors during product manufacturing can be avoided. Furthermore, we introduced an internal certification process: "Made by KSB". It ensures an equally high standard of quality at 13 locations which ex-

ceeds the requirements of the international quality management standard. Our internal certification stands for quality, short delivery times, professional support services and optimum manufacturing processes.

COMBATING CORRUPTION AND BRIBERY (COMPLIANCE)

Our customers and business partners expect KSB to conduct business with integrity. That is why compliance with legal regulations and Group-wide directives is part of our core values. The actions of a single individual can result in a permanent loss of trust in our company and seriously compromise our reputation.

To support employee compliance, we have developed a binding compliance management system. It ensures that legal requirements and internal KSB rules are adhered to, securing the success of our business in the long term. The compliance system is designed to ensure that KSB and its employees always act in line with applicable laws and directives.

Group management is responsible for organising compliance, monitored by the Supervisory Board's Audit Committee. A Group Compliance Officer is responsible for compliance management and reports to Group management on relevant topics every six months. Support is provided by a Group Compliance Committee, consisting of top-level managers from the company.

In the year under review, we revised our Compliance Manual which describes structures and processes to ensure compliant conduct. It also sets out responsibilities and compliance instruments.

A core element of our compliance system is the KSB Code of Conduct which applies across the entire Group. It describes the key legal and business policy principles, providing our employees with guidance for their actions. The Code also sets forth the corporate values which govern our conduct in our daily work: honesty, responsibility, profession-

alism, trust and appreciation. On this basis, we have formulated and communicated specific principles and rules of conduct.

In order to avoid risks resulting from a loss of reputation and legal repercussions, KSB introduced two binding Corporate Directives, one covering compliance with cartel/anti-trust law and one dealing with the prevention of corruption. Both of these directives help to prevent potential violations. Employees receive appropriate training in recognising potential risks and receive practical guidance on impeccable conduct.

Our goal is to train all relevant employees in cartel/anti-trust law and the prevention of corruption. Using a global matrix of requirements, we ensure that all personnel with customer or supplier contact are familiarised with these topics. Currently, 5,240 employees across the Group have received this training. We carry out this training at three-year intervals, with interim demand being met via additional training sessions every six months.

In the event that employees become aware of violations or are unsure whether their actions are compliant, they refer the matter to the compliance organisation, and specifically to the designated Compliance Officer. If necessary, reports will be treated anonymously. In addition, any circumstances that give rise to legal or anti-trust concerns can be reported directly to an independent ombudsperson, who can process potential cases without naming informants. If reliable evidence is presented, then this is pursued. In 2017, the om-

budsperson received one notification of suspected compliance violation. We were also notified of another suspected instance via an e-mail contact form. When the compliance organisation receives relevant information, the necessary steps and measures for clarifying the situation are initiated following a precisely specified procedure. KSB does not tolerate any violations of compliance by its employees. If investigations reveal sufficient evidence of a violation, this will have consequences for the individual concerned. Depending on the severity, sanctions range from a disciplinary warning to immediate termination of employment; law enforcement agencies may also be involved.

RESPECTING HUMAN RIGHTS

By signing the UN Global Compact (see page 20), KSB committed itself to respecting and supporting the protection of international human rights. We have also pledged not to indirectly tolerate violations of human rights, for example when it comes to selecting our suppliers. As a company, we comply with the conventions of the International Labour Organisation ² (ILO). Basic conduct requirements within the workforce are governed by the KSB Code of Conduct. We are aware that human rights infringements are not only morally unacceptable, they can also damage a company's reputation and thus result in financial losses.

KSB is therefore committed to combating all forms of forced and child labour. We do not tolerate any discrimination in our work environment on the basis of individual characteristics such as age, race, religion, appearance, gender, sexual orientation, disability or marital status. Furthermore, we respect the freedom of association and the right to collective bargaining in our companies. We also observe government sanctions such as embargoes and issue internal export control directives.

In order to identify and avoid risks in the supply chain, we practice active supplier management. For every order we place, the supplier declares that it complies with the rules in our Code of Conduct', which corresponds with the human rights principles defined in the UN Global Compact. This

96

Social projects actively supported by KSB or financially supported with at least EUR 5,000

enables us to make sure we avoid purchasing raw materials from areas of conflict where violations of human rights may have been involved in their production. We do not cooperate with companies that are known to have committed human rights violations.

In 2017, we wrote to 1,058 of our strategically most important suppliers asking whether they implement measures to counteract human rights violations. Of the 537 companies that replied, 445 confirmed such measures are implemented.

Our employees can contact the compliance organisation or an ombudsperson regarding human rights issues, following the same procedure as for suspected compliance violations (see page 25).

EMPLOYEE CONCERNS

Our company is defined by the people within it. Their commitment, skills and knowledge ultimately decide our economic success. KSB currently employs more than 15,000 staff. In order to achieve sustainable success, we continue to require well qualified experts. A lack of specialist personnel would harm KSB's economic future.

In order to stand our ground in the intense competition for top talent, we must succeed in recruiting highly qualified

expert engineers, securing their professional development and creating a long-term bond between them and KSB. Potential applicants and colleagues should perceive us as an attractive employer. We foster and develop our own talent to prepare them for high-level specialist and leadership positions, as well as pursuing structured succession planning.

A three-stage scheme enables us to systematically expand our employees' skill sets. It differentiates between company-wide, departmental and individual professional development measures. Annual performance evaluation interviews between managers and staff determine what is required. We offer task-oriented training measures covering technology, business, information technology and communication. In 2017, each member of our staff completed an average of 17.6 hours of professional development activities (KSB AG: 11.9). Regional differences (see chart below) emerge principally due to uneven qualification levels among new employees, meaning that more specialised training is required in some of our companies.

Our range of training options seeks to support our staff throughout their professional life. The goal is to strengthen our colleagues' capacity for self-directed learning, and we intend to initiate a corresponding expansion of the training we offer over the next few years. Our training is delivered using the latest learning techniques including e-learning and

Age structure

Age	Total	KSB AG	Europe*	Asia / Pacific	Americas	Middle East / Africa
Under 25	8 %	12 %	9 %	6 %	8 %	6 %
26 – 39	35 %	28 %	29 %	39 %	38 %	52 %
40 – 54	40 %	36 %	40 %	47 %	36 %	30 %
Over 55	17 %	23 %	22 %	9 %	17 %	13 %

As figures have been rounded, the total may deviate from 100.

* Including KSB AG

Training hours

	Total	KSB AG	Europe*	Asia / Pacific	Americas	Middle East / Africa
Hours per employee	17.6	11.9	14	16	10	65

* Including KSB AG

Health and family: Possibilities for reconciling the commitments of work and family are highly valued by many KSB staff. Family days like the one held at the Halle factory in 2017 allow a glimpse behind the scenes of working life at KSB. At the same time, children get the chance to try out their craft work skills (large image).

In implementing its company health management system, KSB seeks not only to protect its employees against occupational injuries and diseases but also to provide individualised preventive healthcare. At the Frankenthal location, company doctor Parvin Shahidi Asl (small image) looks after employees' health.



Well qualified staff: Innovative companies need specialist staff. Vocational training at KSB means practical learning (image on the left).

A wide range of professional development opportunities for enhancing and expanding new skills are available to employees. These are delivered using the latest learning techniques including e-learning and webinars (image on the right).

webinars. We also value the potential of learning from one another and foster the establishment of communities which facilitate the direct exchange of knowledge and experience.

In order to meet demand for specialist staff, we are continually engaged in training young talent. Our German locations participate in the country's dual vocational education system. In the year under review, we trained a total of 229 young people to take on a role in our company. 2017 saw us invest around EUR 6.6 million in vocational training.

KSB offers attractive prospects for dedicated young people. Promising talent can benefit from a career springboard we provide via vocational training, work placements and student projects.

Those who take up vocational training or dual work/degree programmes with KSB experience practical learning. Alongside specialist skills, we set great store by the sense of responsibility exercised by our trainee staff. They are, for example, also involved in social and ecological projects around their locations.

Many Western countries are experiencing ageing populations, and companies are affected by this demographic shift. We thus monitor the age profiles of our staff in different regions (see chart on page 26) so that we can take timely action in ensuring we achieve the right balance in each company, for example, by recruiting younger trainees in sufficient numbers. It is then possible for us to distribute

valuable knowledge within the company across different age groups.

KSB is committed to diversity and equal opportunities internationally. The binding human resources principles we updated in the year under review harmonise with the conventions of the ILO [\[2\]](#) and apply to all KSB companies. In keeping with these principles, when recruiting we focus solely on the professional requirements of the role to be filled and the individual performance and potential of the candidate. Clear responsibilities have been established to ensure this. Management works to ensure that the principles of equal opportunities and diversity are realised in company practice. Our human resources staff communicate these principles within the Group and adapt them where required. They also foster an awareness of this important topic and offers corresponding training and advice.

We have no doubt that diversity improves performance within our company. So we want to see leadership positions filled by diverse personalities, all giving their best for KSB. As well as recruiting more non-German candidates for management roles, we have set ourselves the goal of increasing the number of women in leadership positions. We wish to be seen as a fair company and an attractive employer for women with all kinds of qualifications. Currently, the proportion of female managers is 11 %. In terms of our workforce as a whole, women make up 15 %. In order to support our female staff, we are strengthening the measures taken by KSB to reconcile the commitments of family and work. Such measures include offering child-

Workforce by gender

	Total	KSB AG	Europe*	Asia / Pacific	Americas	Middle East / Africa
Male employees	85 %	84 %	83 %	89 %	87 %	87 %
Female employees	15 %	16 %	17 %	11 %	13 %	13 %
Male managers	89 %	92 %	89 %	90 %	88 %	90 %
Female managers	11 %	8 %	11 %	10 %	12 %	10 %

* Including KSB AG

care during the school holidays. We also offer advice on caring for family members, and both male and female staff can benefit from our flexible working time models.

We aim to reduce the risk of occupational accidents to avoid injuries to staff and limit periods of leave, with a focus on measures implemented in production areas. Appropriate training sessions, instruction and further preventive measures are implemented regularly. In the year under review, 35 of our manufacturing and assembly plants (including all of KSB AG's factories) were certified according to the OHSAS 18001 occupational health and safety management system. This represents 85 % of our locations. The requirements for prevention set out in the standard serve to increase levels of occupational health and safety.

However, health awareness at work is an important topic also at our administrative departments. We therefore offer training including an annual e-learning course on safety in the office.

Investment in the health and well-being of our staff is also an investment in our own successful future. KSB thus takes a holistic approach to actively implementing its company health management system.

This sees us fulfilling not only the legal requirements of the company health service, but also offering voluntary health-care services such as screening for skin cancer, flu vaccinations and events relating to healthy eating and exercise. Staff aged over 50 are additionally offered an annual preventive medical check-up covering their cardiovascular system, metabolism and musculoskeletal system. If necessary, further tests or treatment are recommended.

KSB greatly values the active engagement of its employees in the development of the company and its work processes. In 2016 we undertook a global survey of around 11,000 members of staff from the Group companies with the highest sales revenues. Respondents offered their opinions on their company, working environment and engagement. The

results revealed opportunities for improvements. These were translated into measures which we promptly started to implement.

SOCIETY

An awareness of our social responsibility motivates us to get involved in social initiatives. As a successful company, KSB is committed to sustainable development and well functioning cooperation within our society. With this goal in mind, and in line with our donation directive, we support organisations and projects dedicated to the education, social support and protection of children and young people. We are also committed to supporting the disadvantaged. In the event of disasters we provide assistance for both people and organisations. In the year under review, we actively participated in or provided financial support of at least EUR 5,000 to a total of 96 social projects.

Education for young people is a core element of our commitment to social issues. It is important for us that young people develop their skills early enough to then pursue a career that offers the right fit for their talents and capabilities. For this reason we joined other companies to found the initiative *Wissensfabrik – Unternehmen für Deutschland e.V.* [Knowledge Factory – Companies for Germany].

The provision of financial support for aid projects has a long tradition at KSB. This includes ongoing support for social developments in the areas around our locations. We donate regularly to projects seeking to supply people with clean drinking water, for which we also provide non-cash support such as pumps.

More information on our social commitment is available at www.ksb.com/csr





DIGITAL TRANS- FORMATION

32	Overview
34	KSB Cloud
38	MyFlow Drive
42	Digital Life Cycle Log
46	Additive Manufacturing
50	Reverse Engineering

Digital Transformation

We seek to harness the potential of digitalisation to achieve high levels of efficiency, performance and fault-free operation. KSB has developed a bold transformation strategy in three key areas.

Products and services

In order to offer user-friendly products and efficient support services, we work together with our customers to establish their needs from technical data to operation. This allows us to pinpoint where digitalisation can unlock new opportunities and develop tailored solutions offering added value.

Internal processes

Implementing the digital transformation helps make our processes quicker, more agile, and thus more effective. KSB's long-term goal is to secure a seamless flow of information between different media: All product data – from development to configuration, production and shipping – should be available at any time and in any location.

Technologies

We are looking to combine our classic engineering expertise with know-how in the digital realm. KSB is therefore investing in developing its own cloud systems, researching materials for 3D printing and building digital infrastructure. This will form a basis from which to offer innovative solutions for the entire product life cycle.



In the future, every smart pump will be connected to the KSB Cloud. A digital copy is created based on all of its data. This "digital twin" enables us to react ahead of time or implement defined measures as soon as operating data indicates that a critical point has been reached.

The KSB Cloud: We are networking our products, processes and services with each other. Reliability, safety and transparency remain central throughout this process. The first digital twins of KSB's smart pumps went live on our network at the beginning of 2018. They replicate the exact conditions of the monitored pump sets. For our customers, this is a step forward in the efficiency and reliability of systems operation. In the future, the KSB Cloud will provide the data basis for all accounting, production and order-handling processes, including simplified spare parts supply.



“We are harnessing the benefits of digitalisation for our customers. In 2018 we will launch to market an innovative pump monitoring unit networked to the cloud.”

2017 saw KSB found a Business Innovation Lab in Mannheim with the aim of developing new digital business models. The idea of combining a start-up environment in the university town with KSB's wealth of experience is paying off: Two new developments have already been implemented – one of them a cloud-based monitoring unit.

Dr. Thomas Paulus

Dr. Thomas Paulus, Head of Digital Transformation, in conversation with Miriam Rischer, KSB Guard project manager



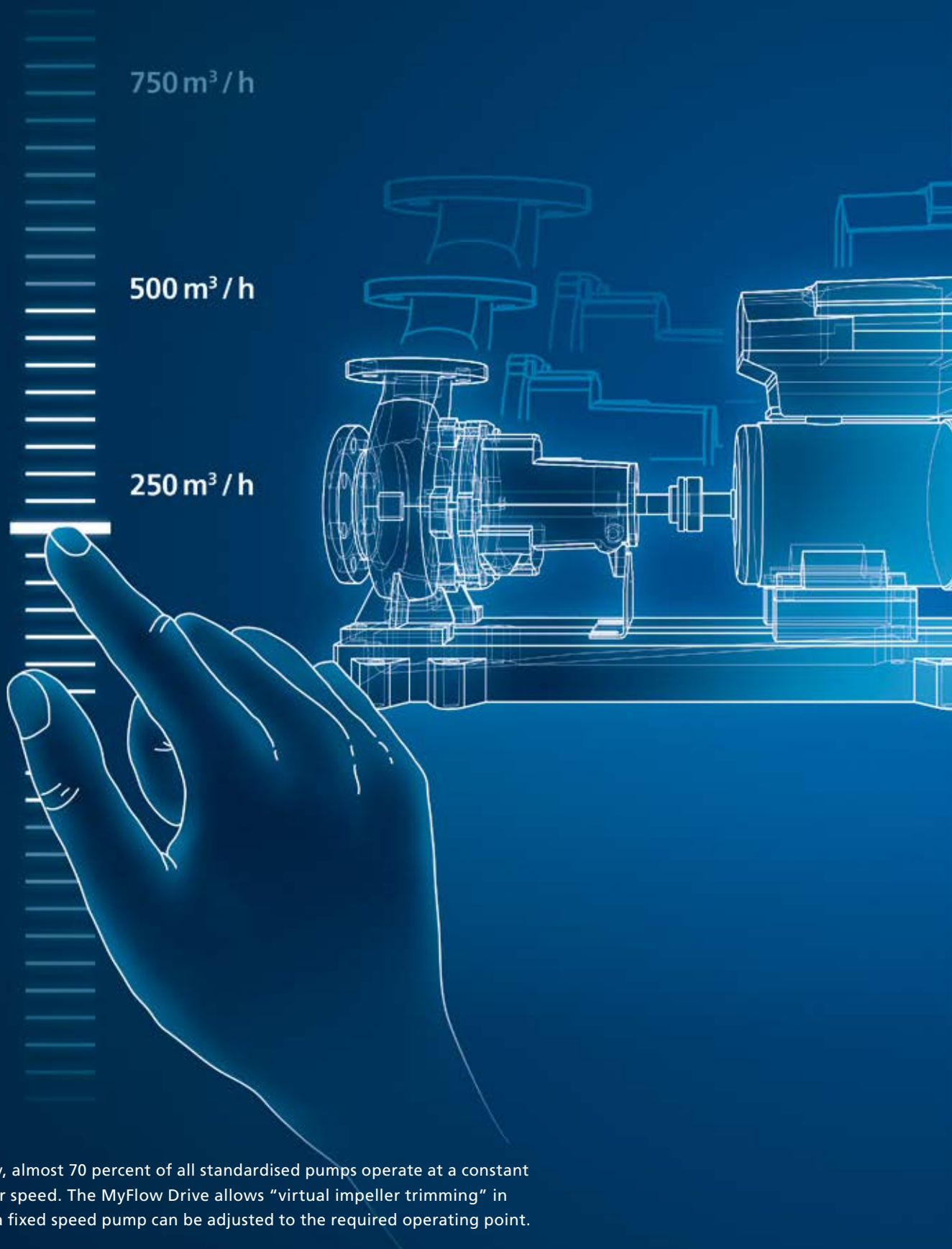

Today, almost 70 percent of all standardised pumps operate at a constant motor speed. The MyFlow Drive allows “virtual impeller trimming” in that a fixed speed pump can be adjusted to the required operating point.

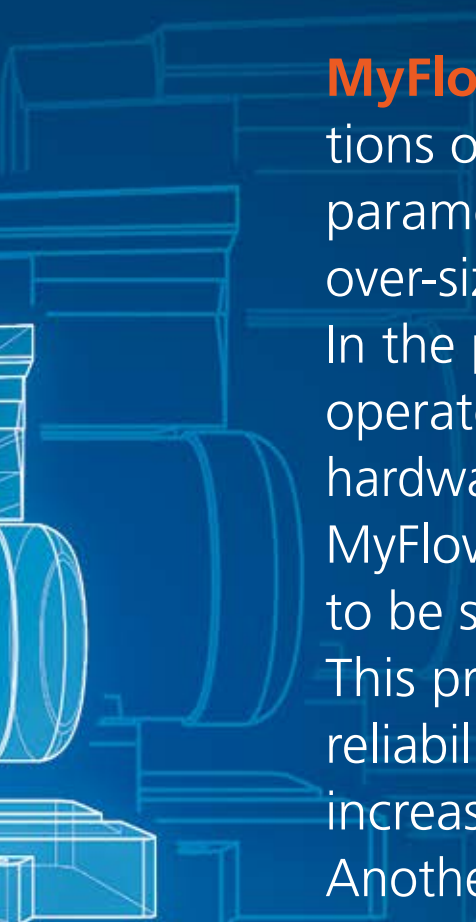
A technical line drawing of a pump assembly, showing various components like the motor, housing, and impeller, rendered in a light blue color against a dark blue background.

MyFlow Drive: A system's operating conditions often differ substantially from the parameters originally planned. As a result, over-sized pump sets are not uncommon. In the past, rectifying the situation required operators to make costly changes to their hardware. The new Industry 4.0-compatible MyFlow Drive allows a fixed motor speed to be set in line with individual requirements. This provides users with greater planning reliability as the pump's flow rate can be increased or decreased quickly and easily. Another plus point: As the minimum frequency inverter modulates the supply voltage of the IE5 synchronous reluctance motor[®], the drive can also be operated on almost any power grid worldwide.

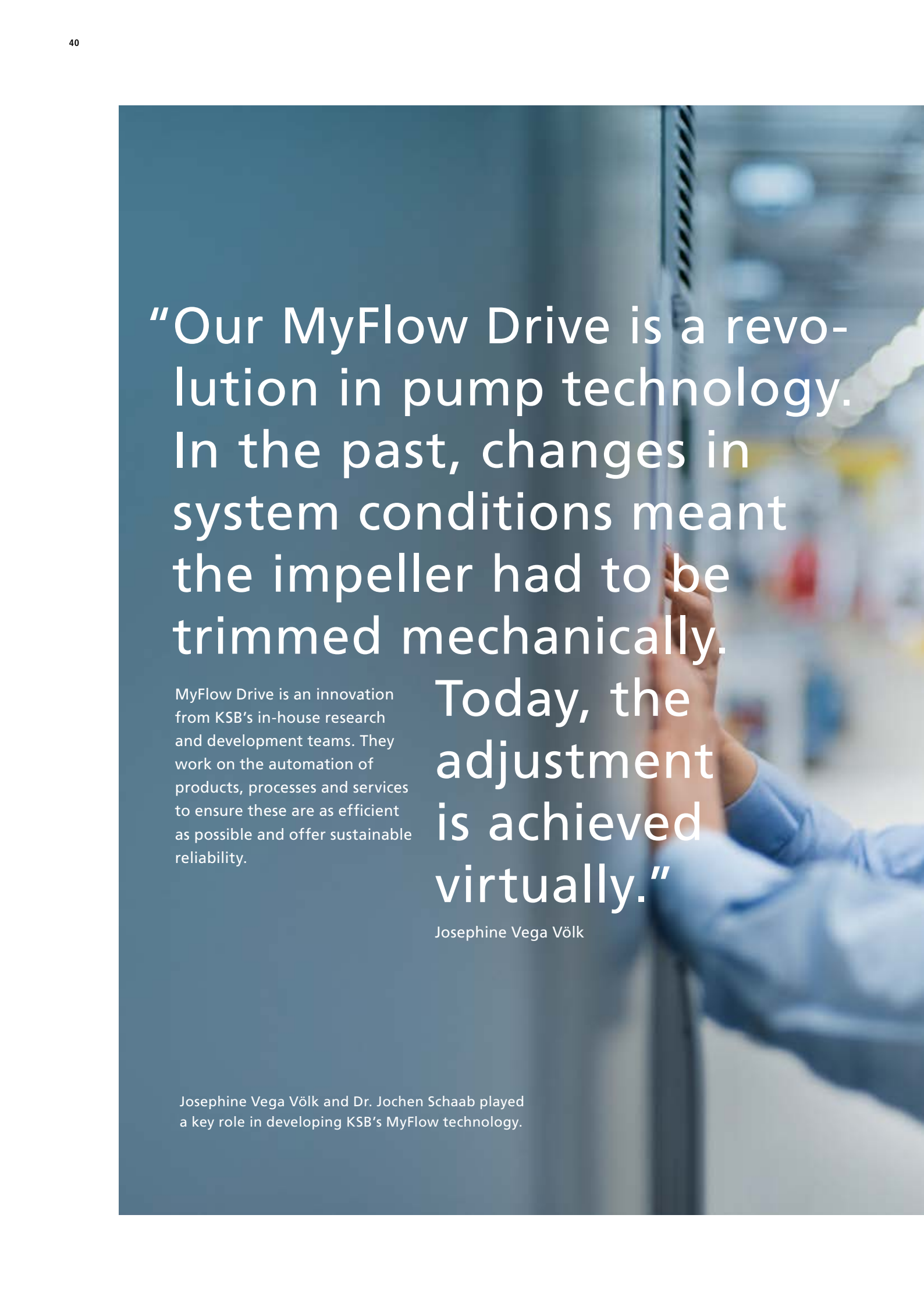
A person wearing a light blue long-sleeved shirt is shown from the side, interacting with a control panel or machine in an industrial setting. The background is blurred, showing various equipment and lights. The overall scene is in a cool, blue-toned color palette.

“Our MyFlow Drive is a revolution in pump technology. In the past, changes in system conditions meant the impeller had to be trimmed mechanically.

MyFlow Drive is an innovation from KSB's in-house research and development teams. They work on the automation of products, processes and services to ensure these are as efficient as possible and offer sustainable reliability.

Today, the adjustment is achieved virtually.”

Josephine Vega Völk

Josephine Vega Völk and Dr. Jochen Schaab played a key role in developing KSB's MyFlow technology.





Pumps and their digital life cycle logs are connected via QR codes.



Digital life cycle logs: Although they may look similar from the outside, pumps can differ from one another hugely in terms of their hydraulic design. We therefore use digital life cycle logs to document the data of each individual pump. These include type series specification and production history, equipment, maintenance information and inspection or test reports. The log is quickly accessible to our on-site technical staff. It helps with maintenance measures and supports process analysis and optimisation during operation. In the long term, this can be considered a bridging technology. As our pumps remain in operation for years and often decades, it will be some time before all of our active pump sets are “smart”. Until this point, QR codes or chips will connect older pump models with their digital logs.



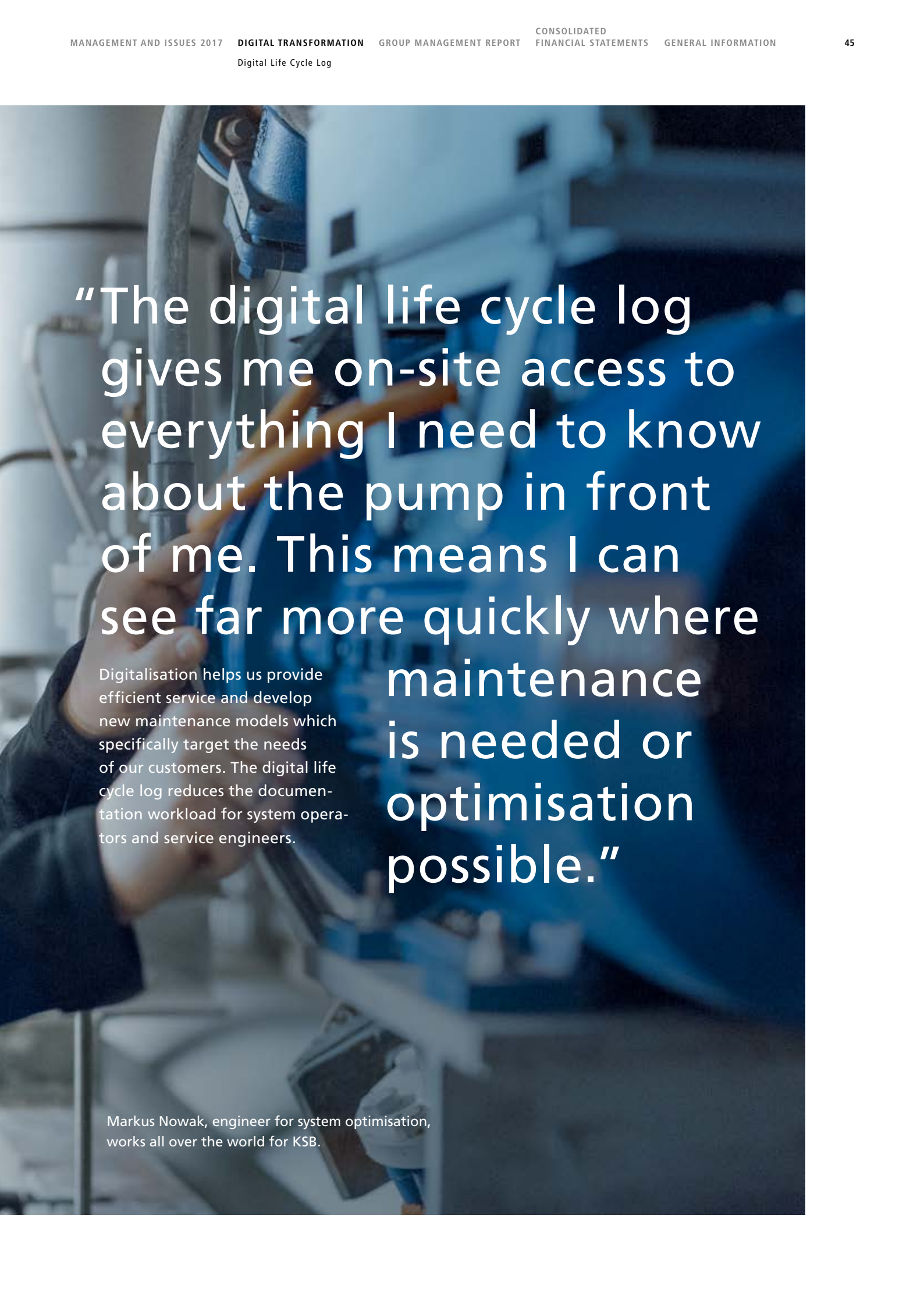

“The digital life cycle log gives me on-site access to everything I need to know about the pump in front of me. This means I can see far more quickly where maintenance is needed or optimisation possible.”

Digitalisation helps us provide efficient service and develop new maintenance models which specifically target the needs of our customers. The digital life cycle log reduces the documentation workload for system operators and service engineers.

Markus Nowak, engineer for system optimisation, works all over the world for KSB.



Laser melting simplifies the production of complex components.

Additive manufacturing: Complex geometrical shapes such as hollow bodies or lattice structures represent the limits of feasibility for classic casting processes. Conventional methods may also make producing components quickly or in small quantities uneconomical. KSB has thus been investing in 3D printing technology for some years. In this innovative process, a laser controlled via a data set melts metal powder onto a platform, creating components layer by layer. It takes specialised know-how and years of experience with materials to ensure that these “printouts” offer the same quality as traditionally cast components. Drawing on this expertise, the technology offers completely new design and manufacturing options.



“I am fascinated by the design possibilities offered by this new technology. Laser melting allows us to produce components which would be impossible to create using conventional processes.”

In order to test and further refine materials and processes, KSB has set up a centre for additive manufacturing in Pegnitz. Here, several laser melting systems are already in operation.

Marco Linhardt, development engineer for additive manufacturing in Pegnitz

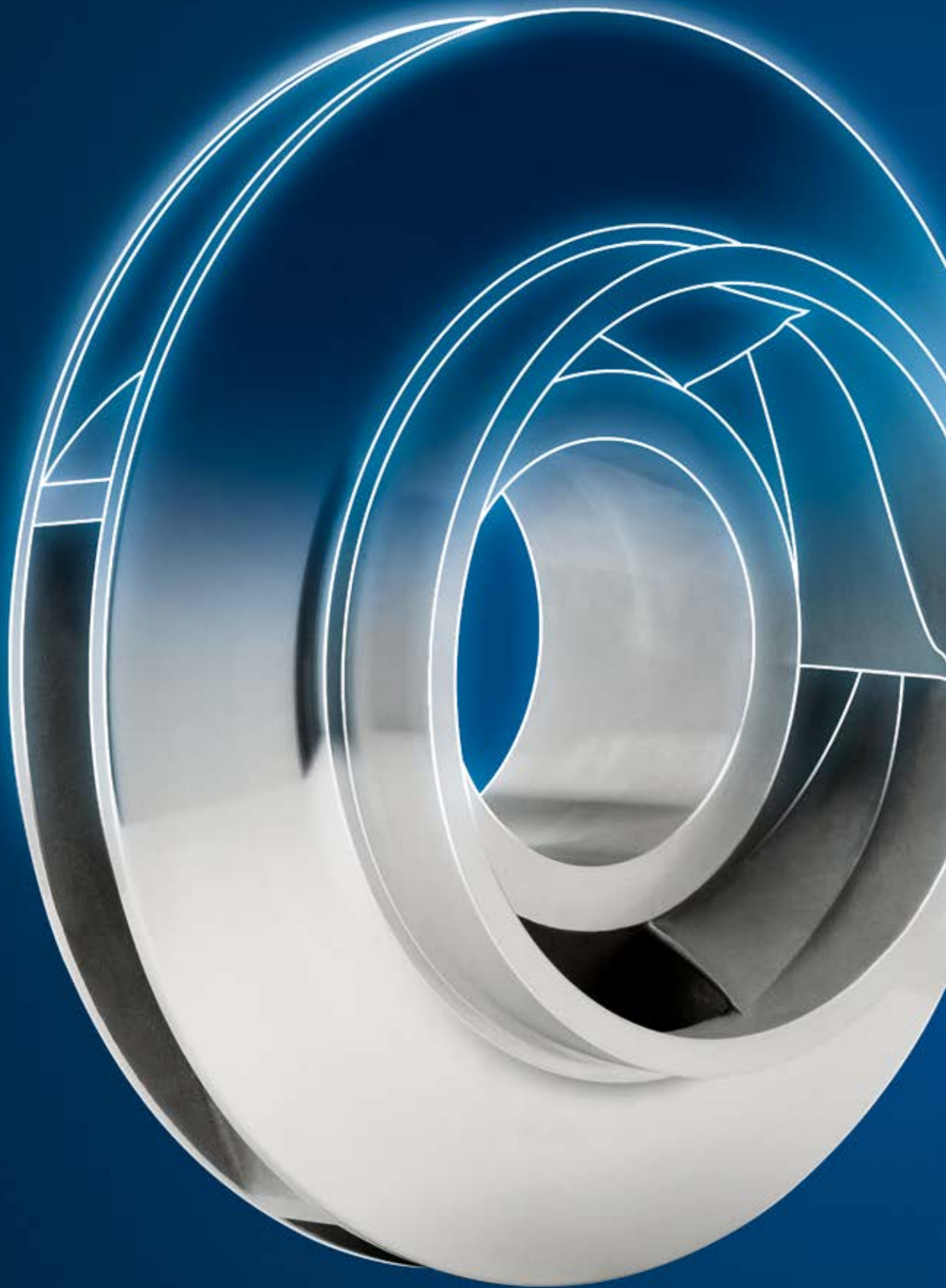

In order to exactly reproduce a pump impeller, KSB scans the original. Damaged areas can then be “repaired” virtually using CAD reconstruction. If requested by the customer, the model can be subjected to a digital flow simulation test using CFD before the impeller is manufactured.

Reverse engineering: Scanning in three dimensions, digitisation, additive manufacturing: This is the new way to reconstruct pump and valve components. When customers need replacement components, quick action is required to minimise their systems' downtime. However, searching for a replacement part can prove challenging. This is particularly the case if neither the part nor the old casting mould are available any longer, or when the delivery period would be too long. A solution is on hand with reverse engineering from KSB. Service specialists scan the original and can virtually reconstruct damaged areas or even partially destroyed components. Depending on the size, they can then print out the component directly or produce a new casting mould. Not only does this technology make replacement parts available quickly, the quality often even exceeds that of the original.

“Our reverse engineering ensures that the customer gets the replacement part quickly, and that its quality is at least as good as the original.”

KSB's US-American subsidiary Standard Alloys is a specialist in spare parts management for pumps and compressors. The company has been refining reverse engineering technology for many years. The process of accurately reproducing components is in no way restricted to the company's own products – it can also be applied to products from manufacturers no longer active on the market.

Richard Martinez

Richard Martinez (right), Managing Director of KSB subsidiary Standard Alloys, in conversation with Rory Novich

Reverse Engineering





GROUP MANAGEMENT REPORT

56	Basic Principles of the Group
56	Group Business Model
58	Control System
58	Research and Development
59	Economic Review
59	Macroeconomic Environment and Sector View
60	Business Development and Results of Operations
64	Financial Position and Net Assets
68	Summary of the Performance in the Financial Year
68	Dependent Company Report
69	Report on Expected Developments
72	Opportunities and Risks Report
84	Acquisition-related Disclosures
86	Corporate Governance Statement (Section 315d of the HGB in Conjunction with Section 289f of the HGB)
87	Statement on the Non-financial Report (Sections 315b, 315c in Conjunction with Sections 289b to 289e of the HGB)
88	Remuneration of the Board of Management

BASIC PRINCIPLES OF THE GROUP

GROUP BUSINESS MODEL

The KSB Group's mission is to supply customers around the world with top-quality pumps and valves as well as related systems. We also provide a wide range of service offerings to users of these products.

KSB SE & Co. KGaA (until 17 January 2018: KSB Aktiengesellschaft), Frankenthal/Pfalz, Germany, as the parent company, directly or indirectly holds the shares in the companies belonging to the Group. Besides it, 9 domestic and 73 foreign companies are fully consolidated; 6 other companies are accounted for under the equity method. KSB is currently represented in over 40 countries with its own subsidiaries.

As well as KSB SE & Co. KGaA itself, the companies in the KSB Group with the highest sales revenue are

- KSB S.A.S., Gennevilliers (Paris), France
- KSB Shanghai Pump Co., Ltd., Shanghai, China
- KSB Pumps Limited, Pimpri (Pune), India
- GIW Industries, Inc., Grovetown/Georgia, USA
- KSB Service GmbH, Frankenthal, Germany
- KSB BRASIL LTDA., Várzea Paulista (Brazil)
- KSB Italia S.p.A., Milan, Italy

Our basic business model has not changed during the year under review. External economic and political changes, however, have had a partial effect on our business. These are – where relevant and material to KSB – described in the following sections.

ORGANISATION, MANAGEMENT AND CONTROL

In the year under review, the Board of Management of KSB Aktiengesellschaft managed and controlled the KSB Group. This body formed of at least two persons under the Articles of Association was assisted in operational decisions by a management team of senior executives. Managers and employees implemented the strategy and instructions of the Board of Management within an organisation that is struc-

tured according to responsibilities for product groups, corporate functions and regions.

All organisational units in the KSB Group act with the aim of ensuring sustainable, profitable growth that will secure both KSB's financial independence and its medium- and long-term future. Management is monitored by a Supervisory Board consisting of twelve members. The Annual General Meeting of shareholders appoints six members of the Supervisory Board, with the remaining six being delegated by the employees under the terms of the *Mitbestimmungsgesetz* [German Co-determination Act].

The KSB Group organises its business activities in three segments based on product groups: Pumps, Valves and Service. The Pumps segment covers single- and multistage pumps, and associated control and drive systems. Applications are industry (manufacturing, chemical/petrochemical, transport), energy supply, water transport and waste water treatment, construction/building services and the hydraulic transport of solids in mining. The Valves segment covers butterfly, globe, gate, control, diaphragm and ball valves, as well as associated actuators and control systems. The applications for these products are essentially identical to those for pumps. The Service segment covers the installation, commissioning, start-up, inspection, servicing, maintenance and repair of pumps, related systems and valves for all these applications, as well as modular service concepts and system analyses for complete systems.

After the reporting period, KSB Aktiengesellschaft changed its legal form to that of an SE & Co. KGaA by entry in the *Handelsregister* [German Commercial Register] on 17 January 2018. The partnership limited by shares [*Kommanditgesellschaft auf Aktien* – KGaA] is a common legal form in Germany for companies with a family- and foundation-dominated ownership structure. The Annual General Meeting of KSB AG adopted a resolution on 10 May 2017 on the announced change in the legal form of the company. The general partner is KSB Management SE, a European public limited company. The shares in this company are wholly owned (100 %) by

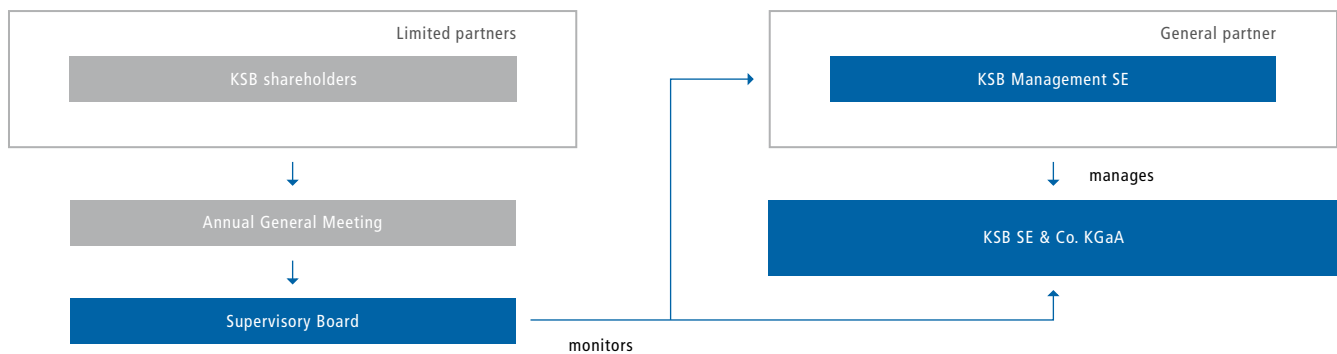
Bodies / Structure

The former KSB Aktiengesellschaft is now managed in the legal form of a partnership limited by shares [*Kommanditgesellschaft auf Aktien* – KGaA]. Management is the responsibility of KSB Management SE, the individually liable general partner. The responsibilities of the bodies are governed by law and the Articles of Associations. This is the basis for efficient corporate governance, which contributes to sustainable corporate growth.

Klein, Schanzlin & Becker GmbH, a subsidiary of the non-profit KSB Stiftung [KSB Foundation] and the Kühborth-Stiftung GmbH [Kühborth Foundation]. KSB SE & Co. KGaA and thus the KSB Group are managed via KSB Management SE, which has four Managing Directors and a five-member Administrative Board.

MARKETS AND LOCATIONS

Within the KSB Group, centrifugal pumps account for around two thirds of sales revenue. These pumps, as well as valves, are sold to engineering contractors, OEMs and end users or, in some cases, distributed via dealers. The same applies to control and monitoring systems, and to package units with pumps and valves.

The best developed sales market for these products is Europe, where KSB operates its main manufacturing facilities in Germany and France. The main plant of the present KSB SE & Co. KGaA in Frankenthal is its largest in Europe, ahead of the production sites in Pegnitz (Bavaria) and Halle (Saxony-Anhalt) in Germany, and La Roche-Chalais in France.

The second-largest market for KSB products is currently the Region Asia/Pacific, followed by the Region Americas and the Region Middle East/Africa. Outside Europe, KSB's biggest manufacturing plants are in Brazil, China, India and the USA.

KSB manufactures products and components in a total of 16 countries; they are sold through the Group's own companies or agencies in more than 100 countries. With their products, the Group companies serve customers in industry including the chemical and petrochemical industries, customers in the energy and construction/building services sectors, transport equipment manufacturers and operators (e.g. ships, rail vehicles), water and waste water utilities, and mining companies. Once again in 2017, the top-selling markets for our products were the industrial and energy supply sectors.

In order to be able to offer our products at favourable prices, we combine the Group's purchasing requirements and source affordable suppliers around the world who meet our quality standards. The focus is currently upon Asian companies. We are able to maintain our market position as one of the leading

pump and valve manufacturers through our good and long-term relationships with our customers and suppliers. Our highly trained and motivated employees as well as the high quality of our products have also helped cement our reputation.

CONTROL SYSTEM

Based upon our matrix organisation, we determine our key financial performance indicators as follows:

Management decisions are taken primarily on the basis of the key indicators that are determined for the Pumps, Valves and Service segments: order intake, sales revenue and earnings before interest and taxes (EBIT). In 2016, instead of the latter control parameter, the operating earnings (EBIT excluding the effects from measuring construction contracts in accordance with IAS 11) were relevant. Following a change in internal reporting, the sales revenue and effects on earnings from construction contracts under IAS 11 have been reported at segment level since January 2017. As a result, sales revenue and EBIT including these effects were reported to Management and decisions taken on this basis in the reporting year under review.

For further information on these key indicators see the Notes to the Consolidated Financial Statements, section VIII. Segment Reporting.

For the control of the entire Group, we use the key indicators of order intake, sales revenue, earnings before income taxes (EBT), pre-tax return on sales as well as the net financial position, and from the 2018 financial year onwards also the earnings before interest and taxes (EBIT). The pre-tax return on sales describes the ratio between the earnings before income taxes (EBT) and the sales revenue; net financial position is the balance of financial liabilities and interest-bearing financial assets (current and non-current financial instruments, interest-bearing loans, cash and cash equivalents, and receivables from cash deposits). When specifying and evaluating

these key indicators, we are guided on the one hand by developments in the market, and on the other by the performance of our key competitors.

We do not consult any non-financial performance indicators for controlling the Group and for making decisions regarding management issues.

RESEARCH AND DEVELOPMENT

Innovations are a fundamental pillar of our activities and are part of the core elements of our strategy. We define them as solutions that create added value for customers and translate into new products, services or business models.

With our pumps and valves, we serve a broad range of technical applications. The integration of hydraulic and electronic systems is a focus of our activities. As many of our products come into contact with fluids that are more or less corrosive or abrasive, materials research is another key area of our developers' work.

In these activities, we are primarily drawing on our strong research and development competencies in Europe and India. In addition, we cooperate with external institutes and research facilities. Overall, we spent around € 47 million on R&D in the year under review. This equates to about 2 % of our sales revenue.

€47 million

Research and development expenses in 2017

Basic Principles of the Group

Control System

Research and Development

Economic Review

Macroeconomic Environment and Sector View

ECONOMIC REVIEW

MACROECONOMIC ENVIRONMENT AND SECTOR VIEW

The growth of the global economy accelerated in the reporting year and at +3.7% developed slightly better than forecast by the International Monetary Fund (IMF) (+3.4%). We regularly consider the forecast figures of the IMF in our annual growth planning. The economic upswing was seen in nearly all countries important for the global economy in 2017 as opposed to previous years.

Among the advanced economies, the euro zone countries (+2.4%) and the US (+2.3%) made particularly good progress. Performance in our European home market continued to be supported by a weak euro, which buttressed the export industry, as well as by low interest rates. They facilitated the financing of investments in industry and the construction sector, which also had a partial impact on our industry. The German economy performed better than expected in this environment, with an increase in the gross domestic product of 2.5%. In this context, local industry production increased above average.

The economy in emerging economies saw a more expansionary trend than in the previous year. In this process, countries exporting commodities and energy sources benefited from tangible price increases. China and India, as the two key markets in Asia for KSB, showed a different performance. Whereas China continued its upswing and slightly exceeded the previous year's growth rate at 6.8%, in India the cash reform and introduction of a national value-added tax prevented a similar rise as in 2016. However, India's economic growth remained at a high level at 6.7%. In Brazil, where KSB continues to be the leading pump supplier, demand for industrial goods rose again after a three-year recession. Production in Russia also saw an upward trend, but the sanctions of Western countries continued to weigh on economic performance.

RISING DEMAND IN KEY SALES INDUSTRIES

Thanks to the improved market conditions, companies caught up with measures to upgrade or expand their technical systems. In this context, plans to boost efficiency and improve plant reliability played a central role. There was a continued trend towards automation of fluid transport systems, which we fit with pumps and valves.

In industry, which is a particularly important market for us, demand rose above all in the manufacturing sector, as well as in the chemical and petrochemical industries. In petrochemical companies, in particular, catch-up effects were the cause of an increase in investments.

In addition to industry, water and waste water management was our second sales focus. In this area, our sales staff faced a market with a strong recovery in demand in the utilities sector. Furthermore, the start of major water supply and waste water treatment projects in China and India resulted in corresponding contracts being awarded.

As a result of the recovery of commodities prices, mining companies made investments to upgrade their plants that had been shelved for some time. In North America, oil sands mining picked up speed again. This is relevant for our business with slurry pumps from the US, which are used for the hydraulic transport of raw materials as well as residues.

Companies engaged in the liquefaction and transport of natural gas continued to largely refrain from investments due to their overcapacities, although gas prices were also on the rise. This made selling our high-performance cryogenic butterfly valves more difficult.

In the energy industry, the trend towards exiting coal continued. By contrast, operators of combined cycle power stations but also of nuclear power plants had a need for equipment goods and support services.

World market of centrifugal pumps and valves

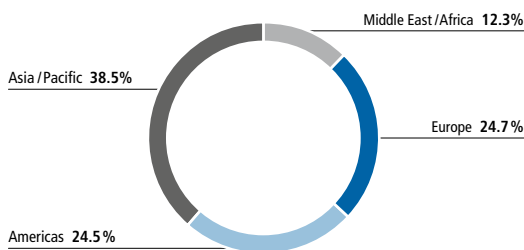

Source: KSB estimate (February 2018), European Industrial Forecasting

In the construction industry, which benefited from the low interest rate level, demand for building services equipment continued to rise. However, this was more pronounced in residential construction than in the construction of commercial and public buildings, where our products are chiefly employed.

UPTURN IN MECHANICAL ENGINEERING

After flat global mechanical engineering sales in 2016, the Oxford Economics research institute registered real growth of 6 % again in 2017. Sales revenue in the European core countries of Germany, France and Italy rose moderately at around 2 to 3%, while growth in the Netherlands, the United Kingdom and several Eastern European countries was stronger by comparison.

In China sales revenue increased by 8 %, and in India by 9 % despite weaker economic growth. In Latin America performance remained at a weak level at merely about 1 % after overcoming the recession in Brazil and Argentina.

The global sales revenue of German plants for the production of liquid pumps performed contrary to the upswing in mechanical engineering overall. They dropped by 0.6 % according to VDMA ² figures. At a plus of 2.3 %, industrial valves sales revenue also fell short of the overall industry's performance.

BUSINESS DEVELOPMENT AND RESULTS OF OPERATIONS

Based on the stronger investment activities of our customers, our business position improved compared with the previous year. This was particularly true for industry and water and waste water management, our key sales markets in strategic terms. In addition, mining companies caught up on a larger scale with investments that had previously been deferred.

We made the most of market opportunities via the global KSB sales organisation, supported by our global manufacturing network, our service organisation and national dealership networks.

ORDER INTAKE

The volume of orders received by KSB increased by € 108.8 million to € 2,265.3 million in the year under review. This 5 % increase corresponds to our expectation of a “marked improvement” in order intake. It is mainly attributable to the development of our business in the water and waste water sector, in industry and in mining. However, we also posted increases with products and services in the power plant business and in service for building services equipment. Currency exchange rate changes constituted – contrary to previous years – only a minor influencing factor at € –7.3 million.

A regional focus of order intake was the Region Asia/Pacific (+13.8 %). The orders received there made up about half of the growth. The companies in the Regions Europe and Americas have also developed positively, with the percentage growth of the American companies (+9.0 %) being stronger than that of the companies in our European home market (+2.8 %). Order intake performance at KSB AG (now KSB SE & Co. KGaA) at +3.8 % to € 780.0 million was above average; here, project orders placed by power stations and industrial plants were a major factor. The companies in the Region Middle East/Africa posted a fall in order intake by 7.7 %, among other things because some major customers placed their orders directly with European KSB companies.

Economic Review

Macroeconomic Environment and Sector View

Business Development and Results of Operations

Pumps

At € 1,473.6 million, the order intake in the pumps segment outperformed the prior-year value by € 87.0 million, corresponding to an increase of 6.3 %, which is in line with our expectation expressed in the previous year. The pump business, which was intensified by sales initiatives and new product launches, benefited from the recovery in the industrial market and the continued good performance of the water and waste water business. In the field of waste water transport and purification, our sales staff won over customers with an enhanced, particularly reliable waste water pump series. We also added new high-pressure and submersible borehole pumps to our water engineering portfolio. In addition, the broadening of our range of mechanical seals manufactured in-house had a positive effect on order intake.

Rising commodity prices strengthened demand from mining, which we served above all with US slurry pumps. In this field, at a 35.5 % increase, we posted the highest growth rate in the pumps segment. The focus was on replacement investments by customers; only a few mine operators tackled expansion projects. The demand situation in the fossil-fuelled power plant business remained challenging; order intake for boiler feed, condensate and cooling water pumps dropped further.

Valves

In the valves segment, we posted order intake up by 3.7 %; it rose by € 12.3 million to € 343.5 million. Most of the orders for globe, gate and butterfly valves came from industry. Chemical and petrochemical companies also placed more purchase orders again. The sale of the valves business of our US subsidiary KSB AMRI, Inc., which had specialised in the production and sale of butterfly valves for chemical applications, had an opposite effect.

The strongest growth rate was posted for orders for globe, gate and butterfly valves for energy generation applications, including high-safety valves for nuclear power plants in Europe and Asia. We did not yet see any improvement in the business with cryogenic butterfly valves for liquefied gas tankers and

loading stations for the reasons outlined above. Our expectation of a significant improvement materialised.

Service

Order intake for support services rose by € 9.4 million to € 448.2 million. This slight increase of 2.1 % correlated with our forecast that growth in service would be weaker than that of pumps and valves. As expected, the sale of a French service company at the end of 2016 and the integration of several service companies into larger units in the USA and France had an opposite effect. In addition, as many as three service sites in the south of the USA were affected by the impact of the tropical hurricane Harvey in 2017.

We posted the strongest order intake overall in the water and waste water business as well as in the power plant sector. Energy providers in China and India, in particular, increasingly used our services. Service orders from mining and building services also rose, only orders from industry remained slightly below the previous year's level.

We were particularly successful regionally in Asia in 2017. There, we are continuously expanding our service organisation, thus winning new customers. 2017, for instance, saw the opening of a service centre in the south of China.

SALES REVENUE

Our consolidated sales revenue improved year on year by € 39.3 million to € 2,205.0 million. This 1.8 % increase slightly exceeded our expectation of reaching the prior-year level. The intensification of our installed base business², which resulted in a higher share of orders with a short-cycle impact on sales revenue, was a positive factor. Exchange rate changes had only a minor impact on sales at € –5.8 million.

The Region with the strongest sales revenue continued to be Europe with a share of some 57 %, where in particular KSB AG (now KSB SE & Co. KGaA) and KSB S.A.S. also process orders from countries outside Europe. Overall, the sales revenue of the European countries rose by 1.4 %. KSB AG saw

a rise of 2.7 % to € 780.8 million (previous year € 760.6 million). The strongest upward development was posted by the Asian companies with growth of 13.0 %. In contrast, sales revenue in the Region Americas (–6.8 %) and the Region Middle East/Africa (–3.6 %) contracted.

As the effects from construction contracts in the 2017 financial year can also be presented at segment level, as described above, the comparison with the prior-year figures is slightly limited.

Pumps

Sales revenue for pumps increased by € 15.9 million, equalling 1.1 %, to € 1,444.4 million. Growth drivers were above all our companies in Asia, with several local companies also invoicing major orders. Due to the lower number of project orders from previous years, however, the general business with standard products and the installed base business² formed the basis of our pump sales revenue. Key growth sectors were the water and waste water sector as well as mining, which we are supplying with replacement pumps and spare parts in greater volumes again. Our expectation of a significant decline did therefore not materialise.

Valves

The rise in order intake did not yet have an impact on sales revenue in the reporting year. The order gap occurring in the project business in previous years was not offset by the developments in the general and installed base business. For that reason, sales revenue dropped again contrary to forecast. It declined by € 21.9 million, or 6.1 %, to € 338.8 million. In this context, the above-mentioned sale of the business of our US valve subsidiary KSB AMRI Inc. reduced sales revenue by about € 7.5 million.

Sales revenue by segment

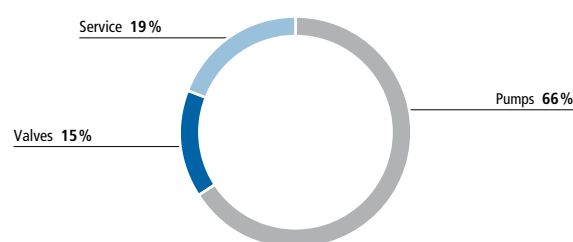

Service

Sales revenue from support services met our expectations of a stable performance. While we assumed at the start of the year that the continued difficult order situation in the energy business and in the oil and gas industry would only permit sales revenue at the previous year's level, we posted growth of € 5.2 million over the year. The sales revenue volume thus rose by 1.2 % to € 421.7 million. In particular the Region Asia/Pacific benefited from the performance of our new service centres.

EARNINGS BEFORE INTEREST AND TAXES (EBIT)

The KSB Group achieved earnings before interest and taxes (EBIT) of € 117.2 million (previous year: € 88.2 million). The Pumps segment contributed EBIT of € 79.9 million (previous year: € 60.9 million). This means that the forecast (of a significant rise) made in the previous year's report was exceeded. In the Valves segment, the predicted substantial growth in EBIT did not materialise; instead, the EBIT dropped to € 0.1 million (previous year € 8.8 million). This was caused by the write-down of the goodwill of KSB Seil Co., Ltd., South Korea. The EBIT of the Service segment rose strongly to € 37.3 million (previous year € 33.3 million), which confirmed our forecast.

In 2016, the preceding section referred to the operating earnings (EBIT excluding the effects from the measurement of construction contracts under IAS 11). An adjustment of the previous year's figures was not possible, as the effects from construction contracts could not be established at segment level. Additional information can be found in Section I. Basic Principles of the Group – Control System.

TOTAL OUTPUT OF OPERATIONS

The above increase in sales revenue is also reflected in a higher total output of operations, totalling € 2,210.5 million compared with € 2,174.2 million in the previous year. Work in progress and inventories of finished goods remained virtually unchanged. Other work performed and capitalised amounts to € 5.6 million and is therefore unchanged year on year.

INCOME AND EXPENSES

Other income declined from € 47.2 million to € 69.2 million, partly due to higher income from the disposal of assets and high insurance compensations.

The cost of materials increased in line with the total output of operations, meaning that the cost of materials as a percent-

age of total output of operations, at 40.2 %, remained unchanged year on year. Overall, the cost of materials increased to € 887.8 million compared with € 874.2 million.

Staff costs fell by 0.3 % to € 796.7 million. Staff costs as a percentage of total output of operations dropped by 0.7 percentage points. The key factor was the continued reduction in headcount. Compared with 2016, the number of employees fell by 117, taking the total figure at the end of the year under review to 15,455. The European companies recorded the strongest decrease with a reduction of 249 staff. The biggest falls came at the French and German sites. Employee numbers were also markedly down in the Americas with 134 fewer people working for KSB on the reporting date compared with the end of December 2016. This development is the result of measures introduced to bring our cost structures into line with new market conditions. The KSB Group employed on average 392 fewer people than in the previous year. Based on the moderately higher total output of operations and simultaneous decrease in the number of employees, the average output per employee improved from € 137 thousand in the previous financial year to € 142 thousand.

The ratio of other expenses to total output of operations rose from 17.1 % to 17.8 %. In absolute terms, this represents a change from € 372.4 million to € 392.4 million. Causes were higher levels of repairs, external services and other staff costs, which could not be offset by lower selling costs.

Financial income/expense improved by € 3.2 million. This is primarily a reflection of the strong increase in income from investments accounted for using the equity method. Based on the contribution to income from our Chinese joint venture, we reported income totalling € 1.5 million. This compares with expenses of € 1.3 million in the previous year.

€ 2.2 billion

Consolidated sales revenue in 2017

EARNINGS

The KSB Group generated earnings before income taxes (EBT) of € 104.2 million, compared with € 74.6 million in 2016.

Our previous year's forecast of a substantial increase in earnings therefore materialised. Correspondingly, the return on sales before tax increased from 3.5 % in the previous year to 4.7 %, also confirming our expectations expressed in 2016.

The income tax rate rose substantially year on year and is now 50.0 % after 36.0 % in the previous year. This rise was attributable to considerably higher deferred tax expenses. Adjusted for the effects resulting from impairment losses on deferred taxes on tax loss carryforwards, the tax rate change in the USA and the write-down of goodwill of KSB Seil Co., Ltd., South Korea, the income tax rate is 37.4 %. Earnings after income taxes, which totalled € 52.1 million (previous year: € 47.8 million) and thus grew by 9.0 %, rose less markedly than earnings before income taxes (EBT) (39.6 %).

At € 14.9 million, earnings attributable to non-controlling interests remained unchanged compared with the previous year. Relative to earnings after income taxes, there was therefore a change from 31.0 % to 28.6 %.

Earnings attributable to shareholders of KSB AG (€ 37.2 million) were € 4.3 million higher than in the previous year (€ 32.9 million).

Earnings per ordinary share were € 21.10, compared with € 18.68 in the previous year, and € 21.36 per preference share, compared with € 18.94 in 2016.

€ **104.2** million

Consolidated earnings (EBT) in 2017

FINANCIAL POSITION AND NET ASSETS

FINANCIAL POSITION

The financial position of the KSB Group remains as solid as ever, as evidenced by a consistently high equity ratio.

Equity

The KSB Group's equity amounts to € 885.4 million (previous year: € 890.3 million). This includes KSB AG's subscribed capital of € 44.8 million as in the previous year. The capital reserve remains unchanged at € 66.7 million. Revenue reserves total € 611.9 million (previous year: € 614.2 million), including the proportion of earnings after taxes attributable to shareholders of KSB AG of € 37.2 million (previous year: € 32.9 million). € 162.1 million (previous year: € 164.6 million) is attributable to non-controlling interests. Due to the lower total equity and liabilities compared with the previous year, down 4.1 %, the equity ratio rose slightly to 39.3 % (previous year: 37.9 %).

The non-controlling interests mainly relate to the following companies: KSB Pumps Limited, India; GIW Industries, Inc., USA; KSB America Corporation, USA and KSB Shanghai Pump Co., Ltd., China.

Liabilities

The largest item under liabilities continues to be provisions for employee benefits, including, also as the largest item, pension provisions, which changed only slightly by € 2.6 million from € 589.5 million to € 586.9 million. A large number of the pension plans currently in place in the KSB Group are defined benefit models. We will be reducing the associated risks, such as demographic changes, inflation and salary increases, for example by increasingly introducing defined contribution plans for new staff.

Our obligations for current pensioners and vested benefits of employees who have left the company account for about 40 % of the amount recognised in the balance sheet. The rest relates to defined benefit obligations for our current employees.

39.3 %

Equity ratio in 2017

Other provisions for employee benefits, which are predominantly current, rose to € 101.5 million (previous year: € 86.9 million).

The development of other provisions, which we created almost exclusively for current uncertain liabilities, was stable (€ 99.8 million compared with € 99.6 million in 2016). An increase in the provisions for warranty obligations and contractual penalties as well as provisions for expected losses from uncompleted transactions offset declining provisions for restructuring measures and provisions for other obligations.

Non-current financial liabilities fell by € 3.7 million to € 54.3 million, which was caused by the reduction in bank loans and overdrafts. The loan against borrower's note, which still amounts to € 48. million, is expected to be repaid in 2019 and 2021.

Current liabilities decreased overall by € 102.7 million (€ 510.8 million compared with € 613.5 million at the 2016 year end). Trade payables rose only slightly to € 212.0 million (€ 210.8 million in the previous year) despite the higher business volume. Other non-financial liabilities increased (+€ 7.2 million), but other financial liabilities fell to the same extent (–€ 7.9 million). The decrease in current financial liabilities by € 98.0 million is attributable to the planned repayment, referred to above, of the loan against borrower's note. Taking into

account the fall in total equity and liabilities, the share of current liabilities in total equity is 22.7 % (previous year: 26.1 %).

Investments

The additions to intangible assets amounting to € 12.5 million (previous year: € 10.0 million) primarily concerned advance payments and own work capitalised for a new software to be deployed in Sales, as in the previous year.

Investments in property, plant and equipment in the reporting year amounted to € 89.4 million, considerably up on the figure of € 72.2 million for the previous year. The highest additions at € 29.0 million (previous year: € 21.1 million) relate to plant and machinery. A further € 20.4 million (previous year: € 23.6 million) relates to advance payments and assets under construction. As in 2016, the focus of our investment activities was Europe, and predominantly Germany and France. Outside of Europe, the highest additions were again made at our plants in India (in particular in Shirwal), in Pakistan, the USA and in China. We maintained our policies for measuring depreciation and amortisation in the year under review.

Net financial position

The net financial position, at € 288.0 million compared with € 259.5 million in the previous year, developed much more favourably than forecast twelve months earlier (€ 240 to 260 million) due to a decrease in trade receivables.

Liquidity

Cash flows from operating activities amounted to € 120.7 million, a year-on-year decrease of € 13.8 million. This was principally attributable to the high commitment of funds in trade receivables and other assets and in inventories (release of funds in previous year). This contrasted with higher advances received and provisions, which failed to offset the commitment of funds.

€ 288 million

Net financial position in 2017

The outflows from our investing activities decreased by € 105.8 million compared with 2016. The return of term deposits and commercial papers increased cash flows considerably. Accordingly, cash flows from investing activities rose significantly to € –8.2 million (previous year: € –114.0 million).

Negative cash flows from financing activities increased strongly, totalling € –106.0 million compared with € –9.6 million in the previous year. The reason are the planned repayments of the loan against borrower's note.

Cash and cash equivalents from all cash flows barely changed from € 288.9 million to € 289.5 million. Exchange rate effects amounting to € –6.8 million (previous year: € +4.3 million) contributed to this.

We assume that, in future, we will continue to be able to meet our outgoing payments largely from operating cash flow. From the current perspective our financial management is meeting the goal of ensuring our liquidity at all times essentially without any additional external financing measures. For more information on liquidity management (such as credit lines) see the section on Risk Reporting on the Utilisation of Financial Instruments elsewhere in this group management report.

Contingencies and commitments

The KSB Group's off-balance sheet contingent liabilities totalled € 16.1 million as at the reporting date (previous year: € 15.9 million). These arise mainly from collateral and performance guarantees.

There are no other extraordinary obligations and commitments beyond the reporting date. Other financial obligations arise only within the normal scope from long-term rental, lease and service agreements (in particular IT and telecommunications) necessary for business operations and from purchase commitments amounting to € 12.2 million (previous year: € 17.9 million).

NET ASSETS

Our total assets fell by 4.1 % to € 2,253.4 million. Considerable decreases were recorded for both non-current assets (particularly deferred tax assets) and for other financial assets. Increases were only recorded in property, plant and equipment and intangible assets, as well as in other non-financial assets.

Around 28.5 % is attributable to fixed assets (previous year: 27.3 %). Intangible assets and property, plant and equipment with a historical cost of € 1,424.3 million (previous year: € 1,393.1 million) have carrying amounts of € 614.3 million (previous year: € 608.2 million). Intangible assets were reduced by € 5.6 million due to the above-mentioned write-down of goodwill of our company KSB Seil Co., Ltd., South Korea. This was more than offset by the advance payments made on intangible assets, meaning that the intangible assets rose from € 106.7 million to € 108.1 million. With investments in property, plant and equipment (€ 89.4 million) once again exceeding write-downs (€ 60.9 million), this balance sheet item increased by € 4.6 million. The carrying amount of financial assets and investments accounted for using the equity method

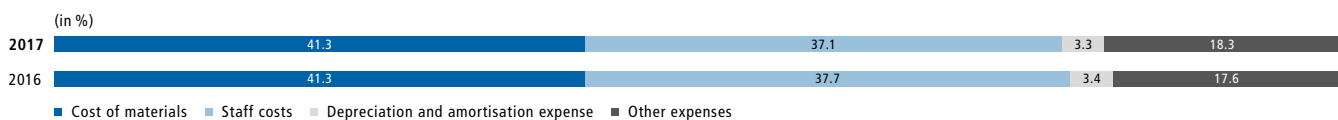
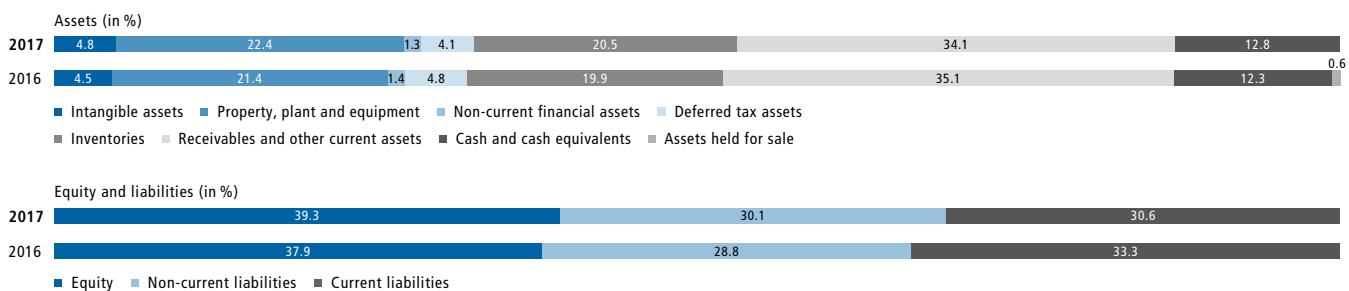
Expenses in statement of comprehensive income**Balance sheet structure**

fell by a total of € 4.7 million to € 28.3 million. The investments accounted for using the equity method accounted for € –2.3 million. Deferred tax assets decreased to € 91.7 million (previous year: € 112.2 million).

Inventories totalled € 461.9 million, down € 5.5 million from the 2016 year end. Materials, consumables and supplies as well as work in progress fell, whereas finished goods and goods purchased and held for resale increased. Inventories continued to tie up around 20 % of our resources.

Despite the higher business volume, trade receivables and PoC could be reduced by € 1.0 million compared with the 2016 year-end figure. Overall – taking into account the change in total assets – this balance sheet item accounts for approximately 27 % (previous year: 26 %) of total assets.

Other financial assets fell from € 187.0 million to € 117.0 million, as we wound up term deposits and commercial papers with a maturity of 3 to 12 months. This is contrasted

by an increase in recoverable taxes from € 18.1 million to € 30.8 million. This increase is attributable to higher receivables from indirect taxes in Asia.

Cash and cash equivalents account for around 13 % of assets, totalling € 289.5 million (previous year: € 288.9 million).

There were no assets held for sale in the financial year, as we sold the valves business of our US subsidiary KSB AMRI Inc., and a Chinese company.

Inflation and exchange rate effects

There were no consolidated companies within the Group whose financial statements were required to be adjusted for the effects of inflation.

The currency translation of financial statements of consolidated companies that are not prepared in euro gave rise to a difference of € –54.1 million (previous year € +20.2 million). This was taken directly to equity.

SUMMARY OF THE PERFORMANCE IN THE FINANCIAL YEAR

The forecasts made in the previous year's report were largely realised due to the circumstances outlined.

We participated in the stronger investment activities of our customers in industry and water and waste water management. Our customers also made previously deferred investments in mining, which had a positive impact on order intake, meaning that the significant improvements in order intake predicted in the previous year materialised. As expected, the growth of the Pumps and Valves segments exceeded the increase in the Service segment.

We slightly exceeded the stable sales revenue predicted in the previous year, although the forecast on the sales revenue development was not realised in all segments. For instance, sales revenue in the Pumps segments rose slightly (forecast in the previous year: significant decline). In the Valves segment, contrary to our expectations of a slight rise, there was a tangible fall. In the Service segment, however, our forecast of stable sales revenue proved correct.

The significant improvement in EBIT predicted in the previous year materialised as expected. In this context, the increase in the Pumps segment exceeded our forecast of significant growth; the substantial improvement predicted for the Service segment was confirmed. In the Valves segment, however, our expectation of a substantial rise did not materialise. Instead, EBIT fell strongly due to the write-down of goodwill of our company KSB Seil Co., Ltd., South Korea. Like the substantial improvement in EBIT outlined above, the earnings before income taxes (EBT) and the return on sales increased as ex-

pected. The earnings before income taxes (EBT) continue to be impacted by one-off costs in the amount of € 50 million, as expected. The net financial position, at € 288.0 million compared with € 259.5 million in the previous year, developed more favourably than predicted twelve months earlier.

Overall, therefore, order intake and sales revenue developed somewhat better than expected in the reporting year. Our expectations for the earnings figures of the Group were met in full overall. This also applies to the return on sales.

KSB continues to have a healthy financial basis for the future.

DEPENDENT COMPANY REPORT

The Board of Management has submitted the dependent company report to the Supervisory Board. This concludes with the following declaration: "In accordance with section 312(3) of the *AktG* [*Aktiengesetz* – German Public Companies Act], we declare that our company – on the basis of the circumstances known to us at the time when the transactions were made – did not receive adequate compensation for all transactions listed in the dependent company report. All disadvantages have been compensated for in the course of the financial year. No measures subject to reporting requirements were undertaken in the financial year."

REPORT ON EXPECTED DEVELOPMENTS

For 2018, the International Monetary Fund expects global growth in real terms of 3.9 %. Accordingly, the dynamic performance of the past year will continue and perhaps accelerate slightly. In this context, the IMF and other institutions assume a synchronous economic development, which includes all key economic areas.

In the industrialised nations, economic development will continue at a comparable growth speed as in 2017 based on expected growth of 2.3 %. Companies in these nations can benefit from growing demand from emerging markets in addition to a good domestic economy. In the euro zone, which is of key significance for our business, the favourable financing options continue to bolster the economic upswing. According to IMF figures, this should result in a gross domestic product that is higher by 2.2 %. Where this goes hand in hand with intensified investment activities, it will have a positive impact on the pumps and valves industry. Boosted by the tax reform, the growth signal in the USA is also green. Investment activities there will likely increase, which will create more favourable framework conditions for the local KSB companies.

The emerging market and developing countries are forecast to see slightly stronger momentum overall, which may result in an increase of 4.9 %. Economic prospects in the countries in Asia and Latin America that are key for our global business are promising. Economists expect 7.4 % GDP growth in India. This goes hand in hand with the expectation that the economy will overcome the uncertainty caused by the cash and tax reform. Our strong local production base will also help us to benefit from the Make in India campaign. In China it is to be expected that the expansionary momentum will drop to 6.6 % due to the politically intended shift towards a service-driven and sustainable economy. This goes hand in hand with measures to stem the growth in debts. The country

remains a key growth market for equipment goods such as pumps and valves despite the slight weakening.

Argentina, Brazil, Chile and Peru will also continue to benefit from the recovery of commodity prices, as will Russia. In particular for our companies in South America, opportunities are therefore increasing to expand their business with pumps, valves and support services. In Russia we can use a new assembly and servicing plant to serve the reviving market in the current financial year.

According to the assessment of the VDMA, the mechanical engineering sector will participate adequately in the global economic performance. Globally, the VDMA expects a real increase of 4 %; its forecast for the German mechanical engineering sector is only slightly weaker at 3.0 %.

As far as manufacturers of liquid pumps in Germany are concerned, the VDMA expects real sales revenue growth of 3 % in the current year; for industrial valves, the association expects an increase of 2 %.

PROSPECTS IN ORDER INTAKE AND SALES REVENUE

The announced continuation of global economic growth is creating good framework conditions for an expansion of our business in and outside Europe. Overall, we are expecting continued growth of our order intake in the current year. This will be based largely on the expansion of our business with standard products, support services and spare parts. In addition, the rising willingness of our customers to invest gives rise to expectations that they will increasingly also tackle major projects. For these, we can supply products tailored to project specifications in addition to standard pumps and valves. Overall, we expect a tangible increase both in order intake and sales revenue.

Gross domestic product growth

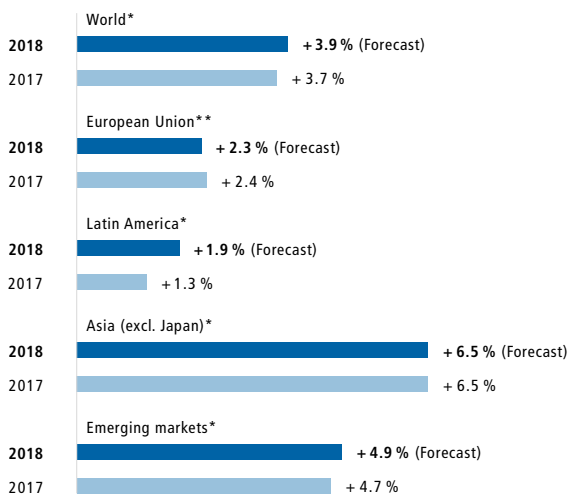

* Source: International Monetary Fund (Januar 2018)

** Source: European Commission (February 2018);
additional information: euro zone +2.4 % (2017), +2.2 % (2018)

Pumps

In the Pumps segment, we expect a strong increase in order intake; sales revenue is expected to grow tangibly. We expect the upward trend in industry and in water and waste water management to continue. To grow in these strategically paramount markets, we will optimise our product range and simultaneously intensify our activities to sell our renowned standard pumps for industrial and municipal water supply globally. To this end, we have expanded our production base and simplified the electronic selection and ordering of our standardised pumps. We also continue to focus on the support of major customers. Thanks to the breadth of our portfolio, which spans building services pumps through to specialised high-pressure pump sets, we can offer them comprehensive customer care.

Valves

As far as order intake for valves is concerned, we expect significant growth driven, in particular, by demand from industry. Above all customers in the oil and gas sector will make investments that they had postponed. At the same time, we expect to be able to use opportunities for the sale of pipeline valves in water transport and the construction industry in Asia to also offer sales opportunities.

By contrast, demand for liquefied gas valves for tankers and loading stations will likely not rise again until the end of the year. We expect a falling order intake trend in the energy sector, where we see hardly any business opportunities in the construction and upgrading of coal power plants, except in Asia. Sales revenue for valves will increase slightly from today's perspective.

Service

In Service, we have set ourselves the target of strong growth for the coming years. 2018 will still see opposing effects, which result from the streamlining of our structures in Germany and France. We nevertheless expect a stable order intake for the current year, whereas sales revenue is likely to grow tangibly.

To this end, we will not least strengthen our valves service, for which we also entered into new framework agreements in 2017. We also intend to expand our range of engineering services. With a view to creating a closer-knit customer service network, we plan to establish new service centres in Southern and Eastern Europe, the Middle East, China and the USA. Relevant acquisitions are also being considered.

In addition, our service range is continuously adapted to accommodate the roll-out of new products. This includes, for instance, the creation of hygienic workstations for the maintenance and repair of pumps for sterile processes. We aim to strengthen and expand the technical and organisational know-how of our specialists at a newly launched international service academy in 2018.

Gross domestic product growth in the BRIC countries

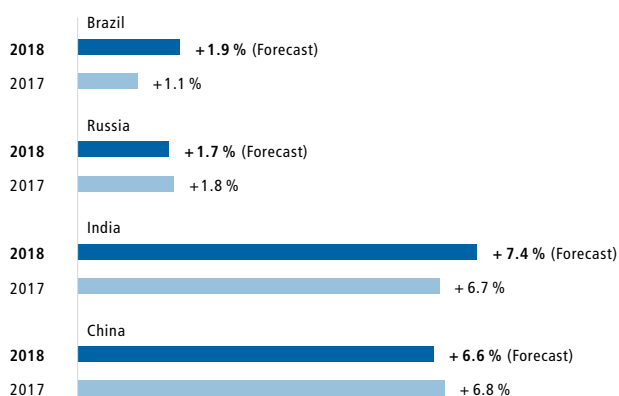

Source: International Monetary Fund (January 2018)

SUMMARY OF EXPECTED DEVELOPMENT

For the current business period, we expect, as outlined above, a tangible improvement in order intake. Major orders will contribute to this, among others in India, where we have expanded our capacities. We expect a strong increase in the Pumps segment. The development in the Valves segment will be slightly weaker, but we still expect a significant increase in order intake. For the Service segment, however, we expect a stable order intake.

We expect sales revenue, too, to rise tangibly overall. In this context, we expect significant growth in the Pumps and Service segments, and a slight rise in the Valves segment.

We will be continuing with our measures for long-term improvements in our profit situation, which were initiated in the previous years. These aim to reduce material, staff and overhead costs. We expect savings that will have a positive effect on future earnings. For 2018, we are planning consolidated earnings before interest and income taxes (EBIT) that should tangibly exceed the prior-year level. EBIT in the pumps segment is planned to rise substantially. In the Service segment, we expect significant increases, while we expect only a

stable earnings contribution from the Valves segment. Among other factors, the one-off development costs for major power plant valves, for which we have already received orders, and the further delay in the recovery of the business with liquefied gas valves are weighing on performance.

In terms of earnings before income taxes (EBT) and the return on sales, our expectation is that both key indicators will increase strongly.

For the net financing position, we plan to achieve a value significantly above the previous year.

The forecast horizon for all the afore-mentioned measures is the 2018 financial year. Material special factors beyond this period may result from our measures geared towards the long-term improvement of our profit situation.

FORWARD-LOOKING STATEMENTS

This report contains forward-looking statements and information that are based upon the assumptions of Management. They express our current forecasts and expectations with regard to future events. As a result, these forward-looking statements and information are exposed to risks and uncertainties that lie outside the Management's sphere of influence. We wish to point out that actual events or results may differ materially from the forward-looking statements and information mentioned, if one or more of the following opportunities or risks, or other opportunities, risks and uncertainties should materialise, or if the assumptions underlying the statements prove to be inaccurate.

OPPORTUNITIES AND RISKS REPORT

As an organisation that operates throughout the world, the KSB Group is exposed to macroeconomic, sector-typical, financial and company-specific risks. Our risk policy is designed to enable us to grow sustainably and profitably. We aim to reduce the risks associated with our business and where possible avoid them completely. At the same time our global alignment and our extensive product range offer a wealth of opportunities. This includes in particular any opportunities that arise on the basis of our research and development activities, as well as any that are linked to the quality and cost effectiveness of our products. Our competitive position is also being strengthened by optimising our global sales and production network. We always review opportunities to expand our global presence and are able to achieve this through start-ups and acquisition projects.

We see opportunities and risks as possible future developments or events that may lead to forecast or target deviation. The deviation can be both positive and negative. In order to manage the varied opportunities and risks professionally and efficiently, we align our actions accordingly and focus upon the respective situation when selecting the persons responsible. In doing so, Controlling, Finance and Accounting as well as Internal Audits perform important monitoring tasks.

RISK MANAGEMENT SYSTEM

KSB has implemented a Group-wide risk management system for identifying and assessing relevant risks and reporting these to Group headquarters. The risk management process of the KSB Group consists of the successive phases of identification, assessment, management, control, documentation and communication of risks. The six phases form a continuous and IT-based closed-loop system. This is documented in our risk management manual as well as the management responsibility and the description of all relevant tasks.

Managers are encouraged to take timely action to define and implement measures to limit or avoid damage that may result from the occurrence of risk events. All corporate and central functions and Group companies, including Group companies

that are not consolidated, are included in the risk management system. The responsible managers are required to supply their relevant key business and financial indicators each month. As well as creating quarterly forecasts on business trends, they also twice a year report the recognised risks for the next 24 months from the reporting date for the categories of market and competitive risks, technological risks, project- and product-related risks, financial risks and procurement risks. Other business risks (environmental, human resources, etc.) are also reported in this cycle to the Risk Managers at the Group headquarters. We classify risks as qualitative and quantitative risks:

Qualitative risks are long-term developments that could have a negative impact on the KSB Group and which cannot or cannot yet be thoroughly quantified due to a lack of precise information. In order to still be able to evaluate them, however, we make estimates of the probability of occurrence and scope. With respect to probability of occurrence, the extent to which the information indicating the potential risk is detailed must be determined. The scope describes the potential influence of the individual risk on the earnings before interest and taxes (EBIT) of the KSB Group or the respective Group company.

Quantitative risks are those risks with possible monetary impact on the earnings of the KSB Group or the respective Group company. They are evaluated taking into account the probability of occurrence in combination with the potential amount of loss.

In order to assess whether qualitative and quantitative individual risks are significant for us, we classify them as acceptable, neutral or significant risks. We consider as material for the KSB Group all individual risks categorised as neutral or significant that are detailed in the “Individually assessed opportunities and risks” section. The relevant classification can be determined from the matrices below:

→ **Qualitative risks – Quantitative risks**

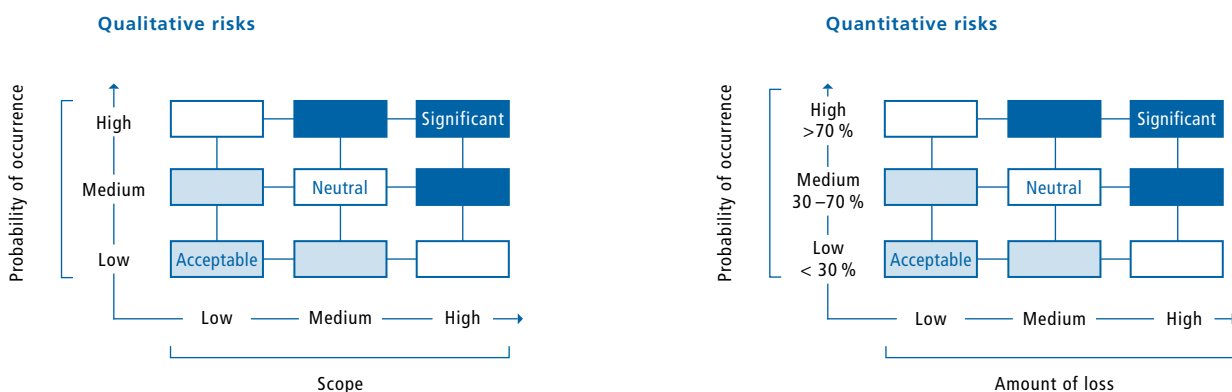

Classification of amount of loss

Magnitude	Sales revenue	Amount of loss in € thousands		
		Low	Medium	High
Small companies	Up to € 20 million	50 – 125	125 – 250	> 250
Medium-sized companies	€ 20 to € 80 million	75 – 250	250 – 500	> 500
Large companies, holding companies, organisational units	From € 80 million	100 – 500	500 – 1,000	> 1,000

Evaluation of the amount of loss is based on just three possible classifications: low, medium and high. The above criteria apply.

→ **Classification of amount of loss**

This approach gives us the necessary transparency to identify risks in their entirety and to manage them effectively, professionally and in an economically responsible manner.

The bodies to which specific responsibilities and competencies were assigned in KSB’s risk management system in the reporting year are shown and explained in the diagram below.

→ **Risk management at KSB**

The Board of Management of KSB AG had overall responsibility for risk management. It reported to the Supervisory Board during regular Audit Committee meetings and was monitored by the latter. The Board of Management was supported by the Chief Compliance Officer and the Group Finance and Accounting department. The latter coordinates the risk man-

agement process at Group level and investigates all reported risks to determine whether they are relevant for the financial statements. It ensures that there is a systematic link with the Group accounting process. The Board of Management and the Supervisory Board’s Audit Committee received at least two risk reports per financial year. These reports include all the risks that are categorised as significant or neutral that exceed pre-defined threshold values individually or collectively, not considering any action that has been taken. Particularly critical topics are reported on an ad-hoc basis by the managers in charge. In contrast, opportunities are not taken into account in this system, but are examined separately in consultation with segment managers and regional managers applying a different assessment system.

With regard to financial risks we also make use of additional risk identification, assessment, management and communication. The central Finance department is responsible for this task which is described in further detail later in this section.

Risk management at KSB

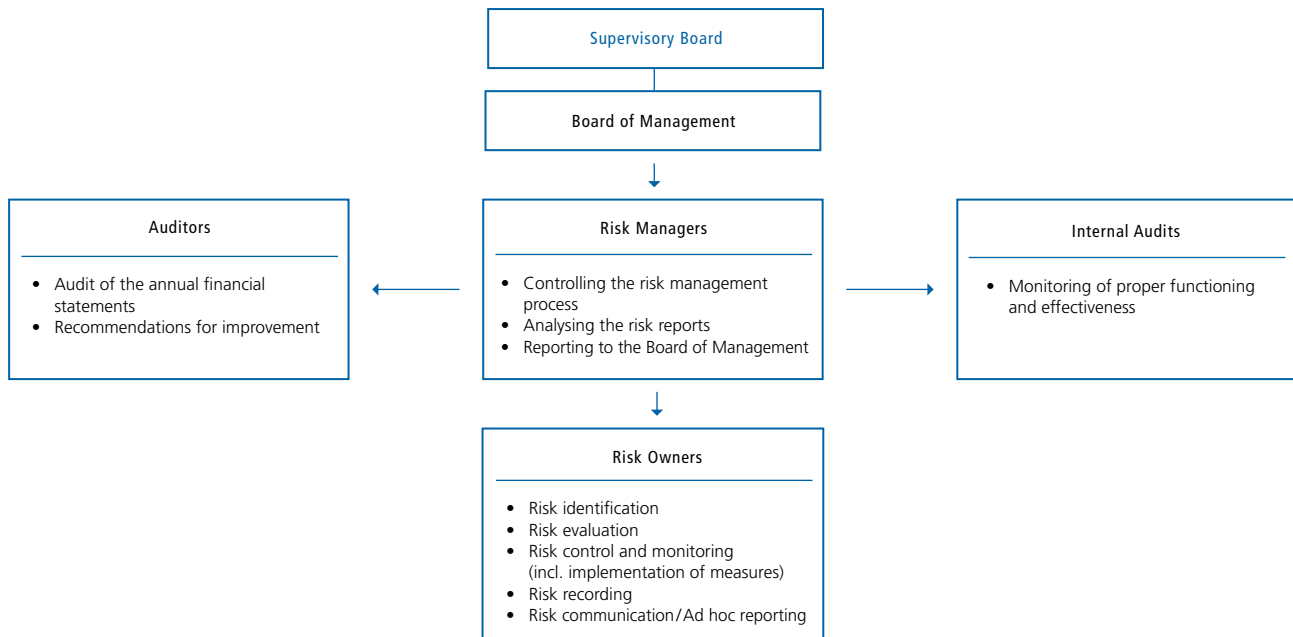

Compliance risks are dealt with by the Chief Compliance Officer, who is assigned to the Legal and Compliance, Patents and Trademarks staff function. The Chief Compliance Officer is supported by the members of the Compliance Committee and the Compliance Managers of the individual companies.

The Internal Audits department is integrated into the risk management system as part of our internal control system. When planning audits, it prioritises areas according to potential risks and is provided with all the necessary information. The auditors ensure that all audited units adhere to the applicable guidelines, actively participate in the risk management system, and control or avoid their risks. Information obtained by Internal Audits on both the recognised risks and the countermeasures introduced in response forms an integral part of the reporting to the Board of Management and the Audit Committee of the Supervisory Board.

Our risk management system is regularly reviewed and promptly updated where necessary, for example, in the event of relevant legal or organisational changes. In addition, our auditor examines within the scope of the annual audit the early risk detection system, establishing that it is present and checking that it is fit for purpose.

INTERNAL CONTROL SYSTEM AND RISK MANAGEMENT SYSTEM WITH REGARD TO THE GROUP ACCOUNTING PROCESS

The accounting-related internal control system (ICS) contributes towards ensuring proper financial reporting. The aim is to ensure that the consolidated financial statements and group management report comply with all relevant regulations. Key elements of the ICS are – as well as the risk management system described above – guidelines and regulations, which include standard accounting and measurement policies. They must be applied to the full extent by all our Group companies. Functional separation and the principle of dual control are observed; this is ensured by the audits carried out by our Internal Audits department.

In addition, the Accounting department carries out regular analytical plausibility checks using time series analyses and actual/budget variance analyses. This enables us to identify significant changes early on, which we then examine for accounting and measurement discrepancies. The resulting findings are then discussed at management level.

The responsibility for Group accounting lies with the employees in the central Accounting KSB Group department. We employ the services of qualified external reviewers for certain calculations as part of financial reporting (such as the calculation of complex pension obligations using actuarial assumptions).

Binding schedules and guidelines apply to accounting within the KSB Group and to accounting at each individual subsidiary. The accounting methods that must be applied to compile the consolidated financial statements are defined in writing in a manual that we update and revise on a continual basis. This also includes the guidelines for posting intra-group transactions. We continually analyse new accounting principles and other official announcements with regard to their relevance and impact on the consolidated financial statements. We adapt our guidelines and manual where necessary and communicate any changes immediately to our companies. Accounting KSB Group monitors compliance with these regulations. This enables us to reduce the risk of compiling inappropriate financial statements or failing to publish them by the defined deadlines.

We automatically process the financial statement information for all Group companies using certified and tested standard consolidation software. Systematic checks are implemented to help us validate the data. Employees in Accounting KSB Group verify any warning signals that arise before using the data. The sequence of the processing steps is strictly specified through the use of the consolidation monitor within our IT system. This ensures the correct processing of data.

To enable a seamless and accurate accounting process, we only assign employees to this task who have the appropriate specialist know-how. These employees are trained on a regu-

lar basis to make sure that their expert knowledge remains up to date.

We have defined access authorisations for the accounting-related IT system. This protects the data against unauthorised access as well as improper usage and modification. The data is checked at many stages, helping to ensure the processing quality. Alongside regular system reviews by the auditors, these checks contribute to limiting operational risks.

INDIVIDUALLY ASSESSED OPPORTUNITIES AND RISKS

The categories presented below – unless stipulated otherwise – include the qualitative and quantitative gross risks classified as significant or neutral and the main opportunities for our business development. The main influencing factor remains the economic development. All other opportunities and risks are assessed as secondary.

Markets / Competition

▪ Risks

Our business opportunities are again affected by changes in the economic and political environments in the current reporting year.

We manage the risk of fluctuations in the economy and in demand by remaining active in several market sectors and industries with different economic cycles. Furthermore we are monitoring the development of the economic environment for our market sectors. If necessary, we adjust capacities, relocate production facilities and implement cost-cutting measures.

Asia remains our most important sales market for power plant equipment, including pumps and valves. However, competition in China intensified further. For the KSB Group, this has created increased pricing pressure and thus represents a “significant” risk. Political decisions too, such as the postponement or even abandonment of energy projects in several Chinese provinces, have impacted negatively on our business performance. In order to tap into the Asian market more widely, we have agreed a strategic alliance with our long-term partner, the Chinese SEC Group, in late 2015. This aims at

closer cooperation so that KSB can achieve success in Asian power plant projects outside of China.

The risk from the political situation in various parts of this world, however, lost some significance year on year. According to our assessment, the framework conditions in the countries of the Region Middle East/Africa, which were presented in the 2016 annual report as risks, are no longer material risks in the financial year. However, the East/West relations that are under considerable strain given the political differences between Russia and the USA, and between Russia and most European countries, continue to be significant. This also becomes apparent in the Russian government's import substitution programme, which constitutes a "significant" risk. Russian companies are to increasingly order products that have been made in Russia or involve a high proportion of local value added. Our KSB company in Moscow has prepared for this development, setting up a local assembly site for industrial and water engineering pumps in leased premises. In addition, an own production site is being established, which will start operations in 2018 according to our plans. Our company almost doubled the domestic value added share already in the reporting year.

We considered the risk of a fall in demand in the petrochemical industry in China in our sales strategy. It is therefore no longer material for our expected business development, contrary to the previous year.

■ Opportunities

Whereas business in the field of fossil-source energy generation remains weak, there is a trend towards growing demand for technical equipment from energy supply companies operating nuclear power stations. Here, KSB sees opportunities as a provider of high-safety components to participate in the supply of equipment, but also to provide maintenance and repair services for such plants with its specially qualified staff.

In China business prospects are arising in the retrofitting² of coal-fired power plants, which are upgraded to become more efficient and environmentally friendly. In addition, KSB Shanghai Pump Co., Ltd. can contribute its expertise to the construction of fossil-fuelled power plants, which Chinese plant engineers are planning and installing in selected countries within the framework of the One Road, One Belt² policy.

In China and India with their strong need to catch up with environmental protection requirements, ongoing action plans offer good opportunities for waste water pumps, which are required in sewage treatment plants and the requisite infrastructure. In India, in particular, which is suffering from serious air pollution, tackling the causes may also increase demand for flue gas desulphurisation pumps from our portfolio.

Projects / Products

■ Risks

The markets' requirements for our products are constantly changing. We will only succeed if we meet our delivery deadlines and offer technically advanced products in good quality at affordable prices. To minimise the risk of delivery delays, which can lead to an adverse effect on our reputation with customers and also result in financial penalties, we constantly monitor our sales and manufacturing operations. If we discover that machinery needs to be renewed or capacities expanded, we examine these investment projects as part of a step-by-step approval process. By doing this, we counter the risk of schedule and cost overruns that is rated as "significant".

Regular market analysis and monitoring minimise the risk that our products will become technically obsolete or that we offer them at prices not acceptable in the market. At the same time, we are exposed to the risk posed by cheap products from Eastern Europe and Asia that compete with KSB's port-

folio. This calls for continuous quality management, which we have introduced across the Group.



In our business, there are special requirements when it comes to the processing of large-scale projects with long contract terms. There are also always associated risks. There may be cost overruns, tighter import regulations, staff shortages, technical difficulties or quality problems – including possible contractual penalties – that reduce our margins. We therefore train our employees in project management and equip them with specialist knowledge. This enables them to identify the risks associated with longer-term orders at an early stage. With this in mind, our project managers are also provided with appropriate management tools. Decisions are made in conjunction with clearly structured authorisation processes.

There are also technical and financial risks to orders with newly designed products. We limit technical risks to the extent that we define intermediate steps for development work and subject partial solutions to assessments. This also applies to pumps that we provide within the framework of a major contract running over a number of years for the construction of a new type of power plant in China. We minimise financial risks by using appropriate contractual clauses, and ensure that advances cover the costs incurred. We set aside suitable provisions for warranty obligations and contractual penalty risks. These amounted to € 51 million in the consolidated financial statements for 2017 compared with € 50 million in the previous year; beyond this there is no other major residual risk (net risk).

The protection of intellectual property is also becoming ever more significant in our increasingly interconnected world. We are addressing a growing risk by registering patents early, monitoring Internet platforms for the sale of pumps and valves and taking legal action against anyone violating our rights.

■ Opportunities

Digital transformation enables us to better fulfil customer requirements with new products and services and to generate competitive advantages. A new pump monitoring system to be launched in the market in the current year serves this aim. It sends values measured by sensors into a cloud for analysis and increases transparency for operators of machinery. As a result, deterioration and damage can be identified early on and appropriate measures be initiated. This can result in a higher number of service orders in the medium term. The introduction of the new SAP C4C  cloud software enables us to better control service processes and to plan assembly assignments precisely.

There are also good chances that our customers will increasingly ask for products newly launched in 2017, such as high-pressure pumps and pressure booster sets, oil pumps to API  standards, waste water pumps with high efficiencies and submersible borehole pumps. This also applies to new valves for use in water pipelines, ANSI  valves for power plants and diaphragm valves with improved pneumatic actuators.

New high-efficiency waste water pumps open up opportunities for KSB BRASIL LTDA. to improve its market position in the waste water market compared with competitors.

The expansion of our range of mechanical seals to more than 30 type series provides added options for fitting pumps for the most varied applications with this core component or for supplying such seals as spare parts. By intensifying the sale of these components produced in-house, we are increasing the value-added depth and thus our pumps business profit.

Finance / Liquidity

■ Risks

As a group with global operations, we are exposed to a wide variety of currency risks. We counter these with foreign exchange hedges. However, our global manufacturing network

also offers us the opportunity to benefit from currency effects and to use these where appropriate in competition with other manufacturers. In addition to uncertainties regarding exchange rates, interest rate developments on the capital markets play a role for us. We use bank loans subject to variable interest rates to counter the interest rate risk by hedging our future interest payment flows accordingly.

Alongside the euro, the most important currencies for the KSB Group are the US dollar, the Indian rupee, the Brazilian real and the Chinese yuan. If the exchange rate differs from our assumptions, this would have positive or negative effects on our business volumes and our earnings. A strict receivables management system and the use of trade credit insurance helps us avoid situations where receivables cannot be collected from our customers.

Risks regarding margins and liquidity are typical of the project business. As well as the continued pressure on our selling prices, which is reducing our profit margins, these include unfavourable contract conditions such as reduced advances and tougher contractual penalties. As we comply exactly with our approval processes in the quotation phase, we minimise this risk. At the same time, this enables us to recognise and avoid liquidity shortages. Where necessary, we secure sufficient liquidity by agreeing appropriate credit lines early on.

Persistent recessions or newly emerging crises may adversely affect the financial situation of our customers. Resulting delays in payment and bad debts which were rated as “significant” in the financial year would weigh on our results of operations. The same effect might occur if the foreign exchange regulations become stricter for individual countries. We counter this by means of a strict receivables management system and intensive customer contacts.

Changing market conditions mean that our business models need to be fundamentally reviewed time and time again. This can also mean that we adjust our product range accordingly.

As regards tax matters, the global orientation of our activities must be taken into consideration. Based on our operative activities in numerous countries with varying tax laws and administrative interpretation, differentiated assessment is required for measuring our tax obligations. Uncertainty may arise due to different interpretations by taxable entities on the one hand and local finance authorities on the other. These may come to light during audits. By cooperating closely with external local tax specialists, we counteract the risk of having to pay back taxes, which is rated as “significant”. As we continually monitor unclear issues, we can generally classify the probability of occurrence. Should a need for subsequent payment arise, we create the corresponding provisions in good time. In the 2017 consolidated financial statements, we set aside € 0 million (previous year: € 1.3 million) for circumstances that are classified as a significant or neutral risk. In addition, there are contingent liabilities in the expected amount of € 1.6 million (previous year: € 7.4 million).

Procurement

■ Risks

Commodity prices and procurement times are subject to strong market-related fluctuations. This may adversely affect our earnings situation if we do not manage to make up for cost increases or pass them onto our customers. Delays or bottlenecks in our supply chain for raw materials and components may negatively impact our business operations. If we do not benefit promptly from declining procurement prices, the persistent pressure on the selling price of our products would have a negative effect on our earnings.

In the context of our procurement strategy, we are also careful to avoid becoming dependent on individual suppliers and thereby counteract the risk of a supplier default. If local conditions mean that it is impossible to ensure sufficient diversification in this regard, we make use of additional foreign business partners. In selected cases, we also integrate external expertise into our company, not least to make the best possible use of our capacity.

Our suppliers are also further developing their product ranges. In some cases, this results in changes to the specifications for the materials that we require. We consistently monitor any potential impact on the quality of our products. Should risks emerge, we reserve higher volumes based on the original material structure, where possible, and assess alternative procurement sources.

■ Opportunities

Process improvements and new forms of the global procurement of materials and services are key elements of our Efficiency Improvement Programme. A reduction in costs is increasingly served by online auctions, which help to achieve favourable purchase prices thanks to the strong competition. The processes, which can be controlled with comparatively few members of staff, reduce the indirect procurement costs and offer the opportunity of a high level of transparency in supplier selection, which we can base on a large number of providers.

Technology / Research and Development

■ Risks

It is essential to our future success that we have a product and service range that is suited to the market in terms of technology, price and delivery time. The changing needs of our customers and new standards and regulations – especially in promising markets such as China – require that we continuously develop and improve our products and services. Research and development required for adjustments consumes significant financial and human resources, with no guarantee of success in either the medium or the long term.

To avoid any negative impact on earnings, it is important to recognise the market-related or technical risks early on. To this end, we are constantly updating our development process, which incorporates various control levels. As sales employees are regularly included in this process, risks arising from changes in markets or applications can be taken into account in good time in the evaluation.

■ Opportunities

At our Business Innovation Lab [BIL](#) we develop new business models on the basis of digital technologies. The aim is to offer customers smart solutions to problems in liquid transport using plant-based data and to simultaneously ensure a high level of security and transparency of their processes. In a test phase, we check these models for functionality and marketability in order to tap new business opportunities.

For example, we deal with application software (apps) for the remote control of our products, the electronic change of fixed speeds – as an alternative to mechanical adjustments – as well as the miniaturisation of power electronics and its integration in the motor. New cooling concepts and loss-reduced semiconductors serve precisely this purpose. In the current year, we will be launching a cloud-based system for pump monitoring into the market for the first time, which will provide users with structured information and early warnings. We see opportunities of receiving orders in a noteworthy volume for this new development as early as in 2018.

With a view to serving our customers in the oil and gas industry, we focused on the development of pumps to API 610 [BIL](#) standards in 2017 and enhanced our range of products for downstream [BIL](#) applications. This opens up opportunities for winning additional orders. Initial order successes for new API [BIL](#) pumps were recorded already in 2017.

As far as pumps for energy engineering are concerned, a focus of our development work was on product adjustments in order to supply combined-cycle power plants in North America with the technical equipment needed. To this end, we expanded our portfolio with new variants of boiler feed and condensate pumps. On the basis of these technological developments, we expect to boost sales in this application area.

We have established a dedicated development team to provide large tubular casing pumps meeting the required specifications. This enables us to produce customised variants of this

product for the project business in a narrow time frame. We received orders for this type of pump in 2017 for cooling water supply and for flood control. The latter will increase in significance on account of global warming. Aiming to expand the business with tubular casing pumps, we are currently driving the development of fish-friendly propellers. They will expand the potential uses of these pumps.

Rapid manufacturing² will have an impact on the availability of parts. Using CAD data, it is today possible to manufacture the components of pumps and valves anywhere in the world. We achieved further progress in the use of additive manufacturing² processes in 2017 and will install a large stainless steel powder bed 3D plant in the current year. The use of this technology allows offering customers new production alternatives and receiving corresponding orders.

Other business-specific risks – Environment

■ Risks

Our business activities, primarily in the area of production, are subject to numerous environmental protection laws and regulations. Environmental damage of any kind (for example, groundwater contamination, renovation needed due to outdated construction materials or unpleasant odours arising from the use of chemicals) may result in losses not covered by an insurance policy. Therefore, at all company sites officers monitor compliance with laws and regulations as well as with internal KSB rules, which in some cases exceed the prescribed environmental standards. If we discover any contamination, we set aside provisions to meet the liabilities for the necessary clean-up work. In the 2017 consolidated financial statements, these amounted to just under € 0.2 million for significant or neutral risks.

As part of acquisition projects, we examine properties for possible contamination before purchase. We take account of critical issues by way of corresponding contractual regula-

tions with the seller and implement appropriate measure in consultation it.

In markets where environmental regulations are becoming more stringent, there is a risk that our products and own or purchased services may cause infringements that lead to us losing our market authorisation and which damage our reputation. A change in rules on liability in environmental protection can also increase the risks for our business success. As a member of national and international professional associations we become aware of imminent changes in environmental law early on. We also continually update the legal frameworks that are in place in our Operational Units, enabling us to ensure that our employees always abide by the applicable law. This is also monitored by external auditors as part of the management certifications.

■ Opportunities

At KSB, environmental awareness is combined with an active and forward-looking approach as well as internal processes that enable permanent cost reductions. This applies, for instance, to all measures that reduce energy consumption in production, service and in the administrative areas. Inversely, we offer the users of our products the opportunity to reduce their electricity costs by selecting energy-efficient KSB products.

Hazards to people and nature may emanate from the production and processing methods of manufacturing companies. Our global environmental management system helps us to identify these risks early on and to initiate protective measures in good time. We thereby not only prevent pollution, but also its financial consequences.

Drawing on a functioning and certified environmental management system, we fulfil a requirement of numerous public-sector customers, large companies and entire industries such as the automotive sector. For them, evidence of an environmental management system is an increasingly important criterion in the selection of suppliers. By having our production

and service plants checked by auditors and certified to international standards, we and our customers are both assured that KSB companies respect the environment. Our commitment to the UN Global Compact [\[2\]](#) also meets the expectations of our customers and improves our order opportunities with companies that pick their suppliers with a view to their responsibility for the environment and society, among other things.

**Other business-specific risks –
 Human resources, legal aspects and IT**

■ **Risks**

To achieve our growth and profitability business objectives, we need qualified employees at all our locations, including technical specialists. Due to the demographic change in some countries, the competition for these and other highly skilled professionals is increasing, and will intensify if economic recovery sets in. We counter this risk with demand-oriented measures, systematic human resources planning and international recruitment processes.

Changing market conditions can have a negative impact on the funded status of our pension obligations. Strong fluctuations in the evaluation of capital market interest rates to be paid may have a considerable impact on the Group's earnings and the equity carried on the balance sheet. To limit this risk, we validate alternative models.

Like all companies, KSB has to adapt to new market conditions. We are currently implementing a global efficiency improvement programme, which also encompasses staff reduction measures. By seeking out socially responsible solutions in the areas of the company concerned and by keeping our employees up to date at all times, we are aiming to keep motivation high and to avoid the departure of employees from key positions.

Changes to our processes and organisational structure, such as the introduction of shared services centres, require clearly defined project responsibilities and valid project plans, as well as the selection of suitably qualified external partners. This helps to avoid teething troubles when changes are introduced to structures and processes, as such problems could impact on the expected cost benefits.

Other potential risks associated with the activities of our employees include dishonest conduct or violations of laws, that could damage the image of KSB. We counter these risks and safeguard our reputation among our customers by organising regular compliance training and through individual initiatives in critical regions.

We address maintenance and repair risks, which could result in production downtime or health hazards for persons, by monitoring them permanently. As soon as necessary refurbishment work is identified, we implement the requisite measures in good time. For instance, we are currently overhauling our heating systems and planning structural measures regarding roofing at the Frankenthal site.

Legal disputes cannot always be avoided within the framework of our business activities. These are usually disputes arising from operations, generally involving unclear warranty issues. If as a result of these issues we expect negative effects on the success of our business, we set aside corresponding provisions, which cover not only the anticipated amount of loss, but also the costs of proceedings. To rule out a net risk, the 2017 consolidated financial statements include about € 1 million (previous year: € 3 million) for those cases classified as significant or neutral risks. We have also created provisions for litigation with authorities and for staff matters. These amount to just under € 3 million overall (previous year: € 2 million) to cover any cases we classify as significant or neutral within our risk assessment methodology. Overall, we rate the risk from legal disputes in the financial year to be significant.

The manipulation and loss of electronic data can lead to serious commercial disadvantages. We limit this risk by means of adequate security systems and access procedures. An increased centralisation of the IT systems of our various operating units assists us in this. In this way, we implement high security standards and thus reduce the risk of data loss or corruption.

■ Opportunities

To remain successful, we need to keep seeking opportunities to optimise our services for customers, simplify processes and reduce costs. In this context, ideas and improvement suggestions by employees provide key impulses. With a view to translating such ideas into innovations, we launched an Internet-based ideas management portal in 2017. Its aim is to generate more employee ideas and to have other portal users provide their comments on or expand them. We will globalise the tool, which was initially rolled out in Germany, in order to use the ideas potential of our employees worldwide.

IMPORTANT OPPORTUNITIES AND RISKS BY SEGMENT

As in the previous year, the opportunities and risks for the Pumps, Valves and Service segments are most influenced by economic development. The future development of China remains important to KSB. Particularly in Eastern Europe, uncertainty regarding political risk is of great significance to the Pumps and Valves segments, and to a lesser degree to Service. Compared with the previous year, we rate the political situation in some countries in the world to be no longer material for the business of the KSB Group. However, political decisions on energy projects in China and the considerable strain on East/West relations continue to be significant risks for us. Worsening payment morale also bears corresponding risk potential for future business. As regards our most significant influencing factor, the economic development, our risk assessment compared with the previous year has changed in that the development of the oil price is no longer a significant risk for the KSB Group. We now assume that the oil price will not recover fully in the coming years, and we have implemented this factor in our strategy. If the oil price were to develop better than expected, however, this would likely have positive effects on our business. The economic development

in general continues to be the most significant risk for us due to the difficulty of assessability. By contrast, we continue to hope that our measures intended to foster growth will provide us with considerable support in achieving our goals. Our customers are also often affected by recessions and more intense competition, which can decrease their ability to pay in individual cases.

Negative currency changes in growth countries could threaten our exports, in particular those from our European plants. But this would also enable our production facilities in the countries affected to benefit from such developments and to increase their export volumes.

RISK REPORT ON THE UTILISATION OF FINANCIAL INSTRUMENTS

Central financial management in the KSB Group performs its duties within the framework of the guidelines laid down by the Board of Management. We base the nature and scope of all financial transactions exclusively on the requirements of our business and do not conduct business of a speculative nature. The aim is to ensure liquidity at all times and to finance our activities under optimal conditions. With respect to our export business, we hedge foreign exchange and credit risks to the greatest extent possible. We continuously improve our receivables management methods with the goal of settling our outstanding amounts by their due dates.

We are exposed to the following financial risks as a consequence of our business activities:

On the one hand, we are exposed to credit risk. We define credit risk as potential default or delays in the receipt of contractually agreed payments. We are also exposed to liquidity risk, which is the risk that an entity will be unable to meet its financial obligations, or will be unable to meet them in full. Finally, we are exposed to market risk. The risk of exchange rate or interest rate changes may adversely affect the economic position of the Group. Risks from fluctuations in the prices of financial instruments are not material for us.

We use foreign exchange hedges to reduce the risks from transactions involving different currencies, These are generally currency forwards, which we use both for transactions that have already been recognised and for future cash flows from orders still to be processed. At year end, the notional volume of currency forwards used to hedge exchange rate risks was € 276.5 million (previous year: € 269.8 million). Foreign currency items denominated in US dollars account for the major volume hedged by forwards. By strengthening our production sites worldwide, we can realise “natural” currency hedging in currency markets that continue to be volatile.

To minimise interest rate risks, we concluded interest rate swaps to hedge cash flows from underlyings amounting to € 0.0 million (previous year: € 39.5 million). Underlyings and hedge transactions share the same variable interest rates and maturities (1 year).

We limit all these risks through an appropriate risk management system, defining how these risks are addressed through guidelines and work instructions. In addition, we monitor the current risk characteristics and continuously provide the information obtained in this way to the Board of Management and the Supervisory Board in the form of standardised reports and individual analyses.

For more information on the three risk areas and the impact on the balance sheet, see the Notes, section VI. Additional Disclosures on Financial Instruments.

OVERALL ASSESSMENT OF OPPORTUNITIES AND RISKS

The opportunities and risks for the KSB Group are mainly derived from macroeconomic influencing factors and their effects on the global mechanical engineering markets and the competition.

The overall risk situation improved a little compared with the previous year. The reason for this is that we no longer rate the oil price to be a significant risk. Overall, we expect an economic performance in line with the IMF ² forecast for next year. Our structural measures will afford us additional support in achieving our objectives. The weakening economic momen-

tum in the growth markets as well as political developments, however, continue to constitute risks, as described in the risk situation by segments. The same applies to geopolitical instabilities, decisions on sanctions and volatile currencies. Such circumstances would have a negative effect on our business volumes as well as our budgeted earnings.

In this environment, the KSB Group continues to rely on its ability to match capacities and resources to the changing market conditions. For us, a solid financial position and an efficient cost structure are vital in order to maintain our long-term competitiveness. We are convinced that we can continue to successfully overcome the risks arising from the above-mentioned challenges.

The risk management system in place as well as the related organisational measures allow the Board of Management to identify risks in a timely manner and to take adequate measures. In view of the somewhat uncertain situation, the focus of activities in 2018 will continue to be on the management of market risks. The Board of Management states that, based on the risk management system established by the KSB Group, at present there are no risks that could lead to a lasting and significant impact on the net assets, financial position and results of the KSB Group.

ACQUISITION-RELATED DISCLOSURES

A summary of the acquisition-related disclosures required by section 315(4) of the *HGB* [*Handelsgesetzbuch* – German Commercial Code] is given below and explanatory information is provided pursuant to sections 175(2) and 176(1) of the *AktG* [*Aktiengesetz* – German Public Companies Act]. Information is disclosed only to the extent that it applies to KSB AG (KSB SE & Co. KGaA since 17 January). In the following, only the term KSB AG will be used.

KSB AG's share capital amounts to € 44.8 million, of which € 22.7 million is represented by 886,615 no-par-value ordinary shares and € 22.1 million by 864,712 no-par-value preference shares. Each no-par-value share represents an equal notional amount of the share capital. All shares are bearer shares. They are listed for trading on the regulated market and are traded in the General Standard segment of the Frankfurt Stock Exchange.

Each ordinary share entitles the holder to one vote at KSB AG's Annual General Meeting. Some 84 % of ordinary shares are held by Johannes und Jacob Klein GmbH, Frankenthal (until 4 May 2017, the company operated as Klein Pumpen GmbH), whose shares are majority-owned by KSB Stiftung [KSB Foundation], Stuttgart. The preference shares carry separate cumulative preferred dividend rights and progressive additional dividend rights. Detailed information on the share capital and shareholders holding an interest of more than 10 % is provided in the Notes to the Consolidated Financial Statements. Holders of preference shares are entitled to voting rights only in the cases prescribed by law. The issue of additional ordinary shares does not require the consent of the preference shareholders. Similarly, the issue of additional preference shares does not require the consent of the preference shareholders pro-

vided that the subscription rights do not exclude newly issued senior or *pari passu* preference shares.

The company is authorised by a resolution passed at the Annual General Meeting on 6 May 2015 to purchase, until 5 May 2020, company shares of any type totalling up to 10 % of the current share capital or, if lower, of the share capital at the time of this authorisation being exercised. The Board of Management shall be entitled to: (1) sell company shares purchased on the basis of this authorisation either on the stock exchange or by another means that safeguards the rule of equal treatment of all shareholders, for example by means of an offer to all of the company's shareholders; (2) sell the acquired shares of the company with the consent of the Supervisory Board, excluding shareholders' subscription rights, if the shares are sold for cash and at a price that is not materially lower than the market price for company shares of the same type and with the same features at the time of the sale. This authorisation is limited to the sale of shares that overall represent no more than 10 % of the existing share capital on the date on which such authorisation becomes effective or, if the amount is lower, the date this authorisation is exercised. The 10 % limit shall be reduced by the proportional amount of share capital for shares (i) issued within the scope of a capital increase during the term of the authorisation excluding subscription rights pursuant to section 186(3) sentence 4 of the *AktG* or (ii) to be issued for the purpose of servicing warrants and convertible bonds, provided that the bonds were issued during the term of the authorisation excluding subscription rights pursuant to section 186(3) sentence 4 of the *AktG*; (3) sell the shares with the consent of the Supervisory Board, excluding shareholders' subscription rights, to third parties for the purpose of acquiring compa-

nies, parts thereof and/or financial interests in companies as well as within the scope of corporate mergers or (4) redeem the acquired shares without any further resolution of the Annual General Meeting in full or in part, including in several partial steps. The redemption may also take place without a capital reduction by adjusting the proportional amount of the other no-par-value shares in the company's share capital. In such cases, the Board of Management shall be authorised by the Articles of Association to adjust the number of no-par-value shares. KSB AG has not yet made use of this authorisation to purchase treasury shares.

There are no resolutions by the Annual General Meeting authorising the company's Board of Management to increase the share capital (authorised capital).

In accordance with its Articles of Association, KSB AG was managed by at least two Board of Management members. The Supervisory Board decided on the appointment and termination of the mandate of members of the Board of Management in accordance with the statutory provisions. Since 17 January 2018, KSB Management SE has conducted the business of KSB SE & Co. KGaA. Under the Articles of Association, the management of KSB SE & Co. KGaA is the responsibility of the Managing Directors.

Amendments to the company's Articles of Association are resolved by the Annual General Meeting. If the amendments only affect the wording of the Articles of Association, they can be made by the Supervisory Board, which operates and is formed in accordance with the regulations of the German Co-determination Act.

CORPORATE GOVERNANCE STATEMENT (SECTION 315d OF THE HGB IN CONJUNCTION WITH SECTION 289f OF THE HGB)

The Corporate Governance Statement pursuant to section 289f of the *HGB* [German Commercial Code] in conjunction with section 315d of the *HGB* dated 21 March 2018 is accessible to the public at www.ksb.com > Investor Relations > Corporate Governance/Corporate Governance Statement.

In addition to the Corporate Governance Report (including the Statement of Compliance in accordance with section 161 of the *Aktiengesetz* [German Public Companies Act]), the Corporate Governance Statement includes relevant information on corporate governance practices applied at KSB SE & Co. KGaA that go beyond statutory requirements. Also described are the working methods of the Board of Management and Supervisory Board, and the composition and working methods of the committees of the Supervisory Board.

Corporate Governance Statement
(Section 315d of the HGB in Conjunction
with Section 289f of the HGB)

Statement on the Non-financial Report
(Sections 315b, 315c in Conjunction with
Sections 289b to 289e of the HGB)

STATEMENT ON THE NON-FINANCIAL REPORT (SECTIONS 315b, 315c IN CONJUNCTION WITH SECTIONS 289b TO 289e OF THE HGB)

The separate combined non-financial report is prepared in accordance with sections 315b, 315c in conjunction with 289b to 289e of the *HGB* and disclosed together with the group management report in accordance with section 325 of the *HGB*. The report can be accessed at: www.non-financial-report2017.ksb.com

REMUNERATION OF THE BOARD OF MANAGEMENT (REMUNERATION REPORT)

The Remuneration Report summarises the principles applied when determining the remuneration arrangements for the Board of Management of KSB AG. It is prepared in accordance with the recommendations of the German Corporate Governance Code (item 4.2.5) and explains the remuneration system in place for Board of Management members. This system is geared towards sustainable corporate development. It is adopted by the Supervisory Board plenary session based on the recommendation of the Personnel Committee and reviewed at regular intervals. The same applies to individual Board of Management compensation amounts.

The remuneration arrangements for the Board of Management were structured as clearly and transparently as possible. The total amount of remuneration for the individual Board of Management members was determined based on various parameters. Criteria for assessing the appropriateness of the remuneration included the responsibilities of the individual Board of Management members, their personal performance, the economic situation, the company's success and prospects as well as customary remuneration amounts when taking peer companies and the remuneration structure used elsewhere within the company into consideration.

The remuneration of the Board of Management consisted of fixed and variable components. Fixed components were granted regardless of performance and consisted of a fixed sum plus benefits, as well as pension commitments (retirement, disability, widow's or orphan's pension). The fixed sum made up 60 % of the maximum annual salary and was paid out as a monthly basic remuneration. All Board of Management members were equally entitled to the accompanying fringe benefits which included the private use of a company car, payment of insurance premiums and any payments associated with a post-contractual non-competition clause. No loans or advance payments were granted to members of the Board of Management in the year under review.

To ensure the sustainability of the nature of the remuneration, the variable remuneration component consisted mainly of future-oriented components determined on the basis of a multi-

year assessment. They were partly based (60 %) on the degree of implementation of the corporate strategy and its actual market success, and partly (20 %) on the return on investment measured according to the economic value added method based on a past average value over a medium-term horizon. The short-term share (20 %) was based on the development of the net financial position in the respective financial year as compared with the planned development. The total amount of the variable remuneration components was limited in order to take extraordinary, unforeseen developments into account.

The weighting factors above do not reflect the additional possibility of a bonus, to be paid out in individual cases at the discretion of the Supervisory Board, of no more than three monthly salary payments per financial year in recognition of any special performance of individual members of the Board of Management. Such decisions are only made on an irregular basis, meaning that they do not necessarily have to be made annually.

In December 2017 the Supervisory Board discussed and decided to adjust the measurement bases for variable remuneration as of 2018. Determination of the long-term components is now carried out on the basis of the net profit plus depreciation/amortisation weighted for 3 years. The short-term share is measured in equal proportions based on the development of the annual EBIT margin, sales revenue and success in the achievement of a personal goal.

Furthermore, when Board of Management contracts are concluded it is agreed that payments made to a Board of Management member in the event of his or her Board of Management tenure being terminated prematurely without good reason shall not exceed the value of two years' remuneration including fringe benefits (settlement cap in accordance with item 4.2.3 of the German Corporate Governance Code). No other payments have been promised to any Board of Management members in the event of termination of service; similarly no compensation will be paid in the event of a takeover offer. If a contract of service is terminated by a Board of Management member for cause, the company shall not make any severance

payments. On 6 May 2015 – using a legally permissible option – the Annual General Meeting again resolved not to disclose the details of the compensation for individual members of the Board of Management for a period of five years.

In total, the short-term benefits (total remuneration) paid to the members of the Board of Management for their activities in the 2017 financial year amounted to € 1,858 thousand (previous year: € 1,250 thousand), and the payments for benefits after termination of work € 1,422 thousand (previous year: € 1,388 thousand). € 2,934 thousand (previous year: € 5,255 thousand) has been provided for pension obligations to current members of the Board of Management, and € 42,202 thousand (previous year: € 39,309 thousand) to former members of the Board of Management and their surviving dependants; total benefits paid to these persons amounted to € 2,422 thousand in the year under review (previous year: € 2,244 thousand). No stock options or other share-based payment arrangements are granted to members of the Board of Management.

The short-term benefits (total remuneration) paid to members of the Supervisory Board amounted to € 834 thousand for the 2017 financial year (previous year: € 716 thousand). Information on the structure of the remuneration arrangements for the Supervisory Board is provided in the Corporate Governance Statement pursuant to section 289f of the *HGB*.

Frankenthal, 21 March 2018

KSB Management SE
The Managing Directors



CONSOLI- DATED FINANCIAL STATEMENTS

92	Balance Sheet
93	Statement of Comprehensive Income
94	Statement of Changes in Equity
96	Statement of Cash Flows
97	Notes
154	List of Shareholdings
158	Supervisory Board
160	Legal Representatives
161	Proposal on the Appropriation of the Net Retained Earnings of KSB SE & Co. KGaA

BALANCE SHEET

Assets

€ thousands	Notes	31 Dec. 2017	31 Dec. 2016
Non-current assets			
Intangible assets	1	108,054	106,596
Property, plant and equipment	2	506,214	501,606
Non-current financial assets	3	6,132	8,526
Investments accounted for using the equity method	4	22,185	24,439
Deferred tax assets	17	91,736	112,166
		734,321	753,333
Current assets			
Inventories	5	461,877	467,437
Trade receivables and PoC	6	613,311	614,293
Other financial assets	6	116,970	186,995
Other non-financial assets	6	37,402	24,923
Cash and cash equivalents	7	289,535	288,883
Assets held for sale	2	–	14,369
		1,519,095	1,596,900
		2,253,416	2,350,233

Equity and liabilities

€ thousands	Notes	31 Dec. 2017	31 Dec. 2016
Equity			
Subscribed capital	8	44,772	44,772
Capital reserve		66,663	66,663
Revenue reserves		611,855	614,238
Equity attributable to shareholders of KSB SE & Co. KGaA		723,290	725,673
Non-controlling interests		162,108	164,661
		885,398	890,334
Non-current liabilities			
Deferred tax liabilities	17	14,703	12,375
Provisions for employee benefits	9	606,875	605,540
Other provisions	9	1,397	1,406
Financial liabilities	10	54,333	57,962
		677,308	677,283
Current liabilities			
Provisions for employee benefits	9	81,472	70,916
Other provisions	9	98,407	98,160
Financial liabilities	10	21,960	119,958
Trade payables	10	212,029	210,813
Other financial liabilities	10	81,467	89,406
Other non-financial liabilities	10	190,161	182,979
Income tax liabilities	10	5,214	9,354
Liabilities held for sale	2	–	1,030
		690,710	782,616
		2,253,416	2,350,233

Also see the relevant information in the Notes.

STATEMENT OF COMPREHENSIVE INCOME

Income statement

€ thousands	Notes	2017	2016
Sales revenue	11	2,204,958	2,165,652
Changes in inventories		-49	2,948
Work performed and capitalised		5,588	5,646
Total output of operations		2,210,497	2,174,246
Other income	12	69,170	47,227
Cost of materials	13	-887,820	-874,156
Staff costs	14	-796,732	-798,750
Depreciation and amortisation expense	1, 2	-70,593	-72,592
Other expenses	15	-392,414	-372,441
Other taxes		-15,753	-13,491
		116,355	90,043
Financial income	16	6,417	6,612
Financial expense	16	-20,106	-20,672
Income from / expense to investments accounted for using the equity method	16	1,514	-1,342
		-12,175	-15,402
Earnings before income taxes		104,180	74,641
Taxes on income	17	-52,076	-26,864
Earnings after income taxes		52,104	47,777
Attributable to:			
Non-controlling interests	18	14,923	14,834
Shareholders of KSB SE & Co. KGaA		37,181	32,943
Diluted and basic earnings per ordinary share (€)	19	21.10	18.68
Diluted and basic earnings per preference share (€)	19	21.36	18.94

Statement of income and expense recognised in equity

€ thousands	Notes	2017	2016
Earnings after income taxes		52,104	47,777
Remeasurement of defined benefit plans	9	9,328	-47,278
Taxes on income		-3,843	13,546
Expense and income recognised directly in equity and not reclassified to profit or loss in subsequent periods		5,485	-33,732
Currency translation differences		-54,238	20,223
Attributable to: Expense and income recognised directly in equity attributable to investments accounted for using the equity method		-2,225	-157
Changes in the fair value of financial instruments		7,203	-1,622
Taxes on income		-2,257	453
Expense and income recognised directly in equity and reclassified to profit or loss in subsequent periods		-49,292	19,054
Other comprehensive income		-43,807	-14,678
Total comprehensive income		8,297	33,099
Attributable to:			
Non-controlling interests		-62	17,836
Shareholders of KSB SE & Co. KGaA		8,359	15,263

Also see the relevant information in the Notes.

STATEMENT OF CHANGES IN EQUITY

€ thousands	Subscribed capital of KSB SE & Co. KGaA	Capital reserve of KSB SE & Co. KGaA
1 Jan. 2016	44,772	66,663
Other comprehensive income	–	–
Earnings after income taxes	–	–
Total comprehensive income	–	–
Dividends paid (Notes No. 8)	–	–
Capital increase / decrease (Notes No. 8)	–	–
Change in consolidated Group / Step acquisitions	–	–
Other	–	–
31 Dec. 2016	44,772	66,663

€ thousands	Subscribed capital of KSB SE & Co. KGaA	Capital reserve of KSB SE & Co. KGaA
1 Jan. 2017	44,772	66,663
Other comprehensive income	–	–
Earnings after income taxes	–	–
Total comprehensive income	–	–
Dividends paid (Notes No. 8)	–	–
Capital increase / decrease (Notes No. 8)	–	–
Change in consolidated Group / Step acquisitions	–	–
Other	–	–
31 Dec. 2017	44,772	66,663

	Equity attributable to shareholders of KSB SE & Co. KGaA	Non-controlling interests	Total equity
Accumulated currency translation differences (€ thousands)			
Balance at 1 Jan. 2016	–61,498	–8,496	–69,994
Change in 2016	16,991	3,232	20,223
Balance at 31 Dec. 2016 / 1 Jan. 2017	–44,507	–5,264	–49,771
Change in 2017	–39,262	–14,881	–54,143
Balance at 31 Dec. 2017	–83,769	–20,145	–103,914

Statement of Changes in Equity

Revenue reserves							
Other comprehensive income							
Other revenue reserves	Currency translation differences	Changes in the fair value of financial instruments	Remeasurement of defined benefit plans	Equity attributable to shareholders of KSB SE & Co. KGaA	Non-controlling interests	Total equity	
813,771	-61,498	-3,342	-139,772	720,594	149,623	870,217	
-	16,991	-1,257	-33,414	-17,680	3,002	-14,678	
32,943	-	-	-	32,943	14,834	47,777	
32,943	16,991	-1,257	-33,414	15,263	17,836	33,099	
-9,857	-	-	-	-9,857	-2,798	-12,655	
-	-	-	-	-	-	-	
-327	-	-	-	-327	-	-327	
-	-	-	-	-	-	-	
836,530	-44,507	-4,599	-173,186	725,673	164,661	890,334	

Revenue reserves							
Other comprehensive income							
Other revenue reserves	Currency translation differences	Changes in the fair value of financial instruments	Remeasurement of defined benefit plans	Equity attributable to shareholders of KSB SE & Co. KGaA	Non-controlling interests	Total equity	
836,530	-44,507	-4,599	-173,186	725,673	164,661	890,334	
-	-39,357	5,036	5,499	-28,822	-14,985	-43,807	
37,181	-	-	-	37,181	14,923	52,104	
37,181	-39,357	5,036	5,499	8,359	-62	8,297	
-9,857	-	-	-	-9,857	-2,491	-12,348	
-	-	-	-	-	-	-	
-980	95	-	-	-885	-	-885	
-	-	-	-	-	-	-	
862,874	-83,769	437	-167,687	723,290	162,108	885,398	

Also see the relevant information in the Notes.

STATEMENT OF CASH FLOWS

€ thousands	2017	2016
Earnings after income taxes	52,104	47,777
Depreciation and amortisation expense / Write-ups	71,445	72,592
Increase in non-current provisions	9,947	14,952
Gain / loss on disposal of fixed assets	-9,150	-208
Other non-cash income / expenses	29	4,714
Cash flow	124,375	139,827
Increase in inventories	-15,725	-11,834
Increase / Decrease in trade receivables and other assets	-21,001	51,091
Increase / Decrease in current provisions	8,231	-8,475
Increase / Decrease in advances received from customers	15,536	-12,161
Increase / Decrease in liabilities (excluding financial liabilities)	10,535	-22,690
Other non-cash expenses (operating)	-1,260	-1,260
	-3,684	-5,329
Cash flows from operating activities	120,691	134,498
Proceeds from disposal of intangible assets	4	90
Payments to acquire intangible assets	-11,941	-11,775
Proceeds from disposal of property, plant and equipment	20,224	2,956
Payments to acquire property, plant and equipment	-88,526	-71,606
Proceeds from disposal of non-current financial assets	218	91
Payments to acquire non-current financial assets	-819	-925
Proceeds from / payments for investments in Group companies that are not fully consolidated	295	-12,044
Proceeds from commercial papers	74,820	-
Payments for commercial papers	-29,979	-74,944
Proceeds from term deposits (maturity of more than 3 and up to 12 months)	55,825	110,027
Payments for term deposits (maturity of more than 3 and up to 12 months)	-28,447	-55,824
Other non-cash expenses / income	165	-
Cash flows from investing activities	-8,161	-113,954
Dividends paid for prior year – Shareholders of KSB SE & Co. KGaA (Notes No. 8)	-9,857	-9,857
Dividends paid for prior year – Non-controlling interests (Notes No. 8)	-2,491	-2,798
Payments for loan against borrower's note	-74,500	-
Payments for / Proceeds from financial liabilities	-19,150	3,044
Cash flows from financing activities	-105,998	-9,611
Changes in cash and cash equivalents	6,532	10,933
Effects of exchange rate changes on cash and cash equivalents	-6,828	4,325
Effects of changes in consolidated Group	948	489
Cash and cash equivalents at beginning of period	288,883	273,136
Cash and cash equivalents at end of period	289,535	288,883

Cash flows from operating activities include cash flows from interest received amounting to € 6,139 thousand (previous year: € 6,357 thousand) and cash flows from income taxes totalling € -40,193 thousand (previous year: € -31,807 thousand). Cash flows from investing activities for the 2017 financial year include cash flows from dividends received of € 1,654 thousand (previous year: € 2,716 thousand). Cash flows from financing activities include cash flows from interest expense of € -8,649 thousand (previous year: € -7,619 thousand).

See also Section VII. Statement of Cash Flows in the Notes to the Consolidated Financial Statements.

NOTES

I. GENERAL INFORMATION ON THE GROUP

KSB SE & Co. KGaA (formerly KSB Aktiengesellschaft), Frankenthal/Pfalz, Germany, is a capital market-oriented partnership limited by shares [*Kommanditgesellschaft auf Aktien*] under the law of the Federal Republic of Germany. The company is registered with the *Handelsregister* [German Commercial Register] of the *Amtsgericht* [Local Court] Ludwigshafen am Rhein, registration No. HRB 65657, and has its registered office in Frankenthal/Pfalz, Germany. After the reporting period, KSB Aktiengesellschaft changed its legal form into that of a SE & Co. KGaA by entry in the German Commercial Register on 17 January 2018. The Annual General Meeting of KSB AG adopted a resolution on 10 May 2017 on the announced change in the legal form of the company. The general partner is KSB Management SE, a European public limited company. The shares in this company are wholly owned (100 %) by Klein, Schanzlin & Becker GmbH, a subsidiary of the non-profit KSB Stiftung [KSB Foundation] and the non-profit Kühborth-Stiftung GmbH [Kühborth Foundation]. KSB SE & Co. KGaA and thus the KSB Group are managed via KSB Management SE, which has four Managing Directors and a five-member Administrative Board.

In the previous year, KSB SE & Co. KGaA and its subsidiaries were included in the consolidated financial statements of Johannes und Jacob Klein GmbH (formerly Klein Pumpen GmbH), Frankenthal, Germany. Johannes und Jacob Klein GmbH, Frankenthal, is the parent company that prepares the consolidated financial statements for the largest group of companies. The consolidated financial statements are published in the *Bundesanzeiger* [German Federal Gazette].

The KSB Group is a global supplier of high-quality pumps, valves and related systems and also provides a wide range of support services to users of these products. The Group's operations are divided into three segments: Pumps, Valves and Service.

Basis of preparation of the consolidated financial statements

The accompanying consolidated financial statements of KSB SE & Co. KGaA were prepared in accordance with the International Financial Reporting Standards (IFRSs) as adopted by the European Union (EU) and the additional requirements of Ger-

man commercial law under section 315e(1) of the *HGB* [*Handelsgesetzbuch* – German Commercial Code]. We applied the Framework, and all Standards applicable at the reporting date and adopted by the European Commission for use in the EU that are of relevance to the KSB Group, as well as the Interpretations issued by the IFRS Interpretations Committee. For the purposes of this document, the term IFRSs includes applicable International Accounting Standards (IASs). The consolidated financial statements of KSB SE & Co. KGaA therefore meet the requirements of the IFRSs as applicable in the EU. The consolidated financial statements were prepared on a going concern basis in accordance with IAS 1.25. They were prepared using the historical cost convention, with the exception of measurement at market value for available-for-sale financial assets and measurement at fair value through profit and loss for financial assets and liabilities (including derivatives). Our investments in joint ventures and associates are measured using the equity method.

The financial year of the companies consolidated is the calendar year.

The income statement as part of the statement of comprehensive income has been prepared using the nature of expense method.

All material items of the balance sheet and the income statement are presented separately and explained in these Notes.

The main accounting policies used to prepare the consolidated financial statements are presented below. The policies described were applied consistently for the reporting periods presented unless stated otherwise.

The consolidated financial statements and the group management report, as well as the annual financial statements and management report of the Group's parent company, are submitted to and published in the *Bundesanzeiger* [German Federal Gazette].

The present consolidated financial statements, due to be approved by the Supervisory Board on 21 March 2018, will be approved for publication on 28 March 2018 by the Managing Directors of KSB Management SE.

IFRS announcement

	First-time application in the EU
Improvements to the International Financial Reporting Standards (2014 to 2016)	1 Jan. 2018
IFRS 15 Revenue from Contracts with Customers	1 Jan. 2018
Clarifications to IFRS 15 Revenue from Contracts with Customers	1 Jan. 2018
IFRS 9 Financial Instruments	1 Jan. 2018
IFRS 2 Share-based Payment	1 Jan. 2018
IFRS 4 Insurance Contracts	1 Jan. 2018
IFRIC 22 Foreign Currency Transactions and Advance Consideration	1 Jan. 2018
IAS 40 Investment Property	1 Jan. 2018
IAS 28 Investments in Associates and Joint Ventures and IFRS 10 Consolidated Financial Statements	1 Jan. 2019
IFRS 16 Leases	1 Jan. 2019
IFRIC 23 Uncertainty over Income Tax Treatment	1 Jan. 2019
IAS 19 Employee Benefits	1 Jan. 2019
Improvements to the International Financial Reporting Standards (2015 to 2017)	1 Jan. 2019
IFRS 17 Insurance Contracts	1 Jan. 2021

New accounting principles

a) Accounting principles applied for the first time in the 2017 financial year

The following new and revised Standards issued by the International Accounting Standards Board (IASB) were required to be applied for the first time in financial year 2017:

The amendment to **IAS 12 Income taxes** clarifies that write-downs to a lower market value of debt instruments measured at fair value arising from a change in market interest rates can give rise to deductible temporary differences. For clarification, rules and examples were expanded, for example, to indicate how future taxable income needs to be calculated in order to capitalise deferred tax assets.

The amendment to **IAS 7 Statement of Cash Flows** aims to add information that will help users of financial statements to assess changes in the entity's liabilities from financing activities. The "Changes in cash flows from financing activities" table in Section VII. Statement of Cash Flows has thus been supplemented.

Three IFRS standards were amended by the **Annual Improvements to IFRS Standards – 2014–2016 Cycle**, with only the following amendment being required to be applied in 2017: IFRS 12 clarifies that on principle the disclosure requirements also apply to interests in subsidiaries, joint ventures and associates that are classified as held for sale as defined by the IFRSs. Exceptions are disclosures under IFRS 12.B10–B12 (financial information). This clarification does not have any impact on our reporting.

b) Accounting principles that have been published but that are not yet mandatory

The following standards and revised standards issued by the IFRS Interpretations Committee (IFRIC) were not yet mandatory and were not applied in the 2017 financial year:

→ [IFRS announcement](#)

In May 2014, the IASB published the new **IFRS 15 Revenue from Contracts with Customers** standard. The new accounting standard, which is to be applied to financial years that begin on

or after 1 January 2018, defines principles that an entity should apply when reporting on the nature, amount, timing and uncertainty of revenue and cash flows arising from a contract with a customer. Sales revenue is recognised when the customer has control over the agreed goods and services and can derive benefits from these. It supersedes the previous IAS 11 Construction Contracts and IAS 18 Revenue standards.

KSB will not apply IFRS 15 early for the first time, instead deciding to initially apply the standard in the 2018 financial year using the modified retrospective method. The cumulated impact on earnings resulting from the transition will be recognised directly in equity at the beginning of the comparative period.

The focus of the Group-wide project to introduce IFRS 15, underway since 2016, has been on ensuring complete identification of the resulting effects, training the Group companies, creating and implementing the technical concept, and analysing the materiality of the identified effects of IFRS 15. The impact analysis carried out in the 2017 financial year confirmed our assumptions that no material effects are to be expected.

We expect minimal effects for the construction contracts recognised using the percentage-of-completion method until the end of the 2017 financial year. For a number of these contracts, the criteria laid down in IFRS 15.35 for sales revenue recognition over time were not fulfilled. This led to sales revenue being recognised later. At the moment, we expect reported consolidated sales revenue to decrease by approx. 2%. In the consolidated balance sheet there will be reclassifications between receivables recognised by PoC and contractual assets under Assets, and between advances received from customers PoC and contractual liabilities under Equity and Liabilities.

In July 2014, the IASB published **IFRS 9 Financial Instruments** as the successor to IFRS 39 Financial Instruments: Recognition and Measurement. IFRS 9 specifies revised rules for classifying and measuring financial instruments, new rules regarding the impairment of financial assets and additional rules for recognising hedges.

The rules for *classification* of financial instruments under IFRS 9 are based on the following two criteria: the business model – hold or sell – and the type of cash flows – repayment of principal or interest. Changes to the financial liabilities measured at fair value were fully recognised in the income statement under IFRS 39, while IFRS 9 requires a separate treatment. If changes are a result of credit risk developments, then they are to be recognised in other comprehensive income; other changes will be recognised in the income statement. As the Group currently measures all of its financial liabilities at amortised cost, and intends to maintain this approach, no material effects on financial liabilities are to be expected from the application of IFRS 9. Based on our review, the measurement of financial assets will remain mostly unaffected by the changes.

According to the new rules regarding *impairment* the incurred loss model (retrospective) applied under IAS 39 is to be replaced by the expected credit loss model (prospective). The standard stipulates a general 3-stage model (impairment model) and a simplified method for determining the anticipated impairment. For all financial instruments that fall within the scope of the new impairment model, the calculated prospective impairment needs to be recorded at the time of initial recognition based on a valid future estimation. The Group intends to apply the simplified method for the measurement of trade receivables. As far as the relevant impairment losses are concerned, the Group expects an increase of approx. 1% in relation to the current receivables.

IFRS 9 also requires a calculation of expected credit loss (ECL) for investments (term deposits) with a maturity of more than three months, investments in Euro Commercial Papers (ECP) and loans to third parties. When transitioning to IFRS 9, the effect of the first-time application of the standard will be taken directly to equity. Subsequent changes will be recognised in profit or loss. However, we do not expect any material impact in this respect.

In addition, IFRS 9 covers hedge accounting. A particular focus is on the presentation of cross-currency basis spreads as derivative components. KSB currently intends to use the option of excluding the forwards points and cross-currency basis spread component. The effects will thus be recognised directly in equity as “Cost of hedging reserve” under a new item in other comprehensive income. We do not expect any material effects in this respect.

Furthermore, any hedges need to be consistent with the objectives and strategy of Group risk management in order to better present the associated activities. It is expected that the hedge accounting relations of the Group meet all requirements of IFRS 9.

KSB will apply the IFRS 9 accounting rules for the first time in the 2018 financial year. Comparative disclosures will not be adjusted. Consequently, all differences between the carrying amounts of the financial instruments before and after the application of IFRS 9 will be recognised in revenue reserves and other reserves as of 1 January 2018.

The amendments to **IFRS 2 Share-based Payment** relate to the accounting treatment of cash-settled share-based payment transactions. Some of the new provisions concern the calculation of the fair value of obligations resulting from share-based payments.

The changes to **IFRS 4 Insurance Contracts** aim to reduce the impact of the differing start dates for IFRS 9 Financial Instruments and the successor standard to IFRS 4, above all for entities with comprehensive insurance activities.

IFRIC 22 Foreign Currency Transactions and Advance Consideration clarifies the exchange rate to be used on initial recognition for the conversion of foreign currency transactions that include the receipt or payment of advance consideration.

IAS 40 Investment Property has been amended in order to clarify that an entity may only transfer a property to or out of its investment property portfolio if there is evidence of a change of use.

The amendments to **IAS 28 Investments in Associates and Joint Ventures** and **IFRS 10 Consolidated Financial Statements** remove an inconsistency between the rules laid down in the Standards for dealing with assets being sold to an associate or joint venture and/or the contribution of assets in an associate or joint venture. In future, any gain or loss arising from the loss of control over a subsidiary that is being incorporated into a joint venture or associate must be recognised in the full amount by the investor if the transaction relates to a business as defined in IFRS 3 Business Combinations. If, in contrast, the assets do not form a business, the gain/loss may only be recognised pro rata. On 12 October 2017, the IASB published amendments regarding accounting for long-term interests in associates and joint ventures. The amendments to IAS 28 clarify that IFRS 9 is to be applied to long-term interests in associates or joint ventures that are not accounted for using the equity method.

IFRS 16 Leases specifies the new rules on recognising, measuring, presenting and disclosing leases. The classification into operating and finance leases shall no longer apply to lessees in future. Pursuant to IFRS 16, all leases shall as a general rule be accounted for in the form of a right of use with corresponding lease obligation. These are to be reported in separate balance sheet items under fixed assets or liabilities, or may be described in the Notes.

As far as lessees are concerned, the new standard offers various accounting options. Leases with a term of less than 12 months and low-value assets may be capitalised. If this option is used, the lease will be accounted for in a comparable way to that stipulated to date under IAS 17 for operating leases. A further simplification is provided by the option of applying the new rules to a lease portfolio, provided that the resulting effect does not involve any significant change compared with an individual approach.

Comprehensive qualitative and quantitative disclosures will be required in the Notes in future.

Based on current knowledge, IFRS 16 will be applied for the first time on a modified, retrospective basis within the KSB Group by recording the cumulative effect from the first-time application in equity. On this basis, only those existing contracts that are already classified as leases under IAS 17 will be covered by the scope of IFRS 16. Other existing contracts need not be reviewed to determine whether they would be covered by the new standard based on the amended definitions in IFRS 16. For the Group, this means that the assets and liabilities for operating leases already in place must be reported. The discounted residual lease payments are to be recognised as a lease liability. The right of use can either be recognised at the amount that would have resulted from application of the standard at the start of the lease or, more simply, at the amount of the liability (adjusted to take account of any payments before the lease began).

Information on the current leases applicable within the Group are included in Section IX. Other Disclosures of the present Notes. Based on current information, we will be exercising the options applicable to leases with a term of less than 12 months and low-value assets in such a way that we account for these leases in a comparable way to that stipulated to date under IAS 17 for operating leases. Other leases result in a balance sheet extension, which, however, will not correspond to the full scope of the operating lease volume (€ 49.7 million) presented in Section IX. Other Disclosures. There will also be a change in the income statement, given that lease payments for operating leases currently reported under other expenses will in future be partially replaced with a depreciation expense for rights of use and interest expenses for liabilities from leases. Within the statement of cash flows, too, the first-time application of IFRS 16 will result in shifts between the individual cash flows. However, because the redemption component of lease payments in the future will be an element of cash flows from financing activities, this will result in an improvement of cash flows from operating activities. Accounting for finance leases in place will not be affected by the new standard.

In order to estimate the workload and expense for the first-time application and ensure the correct implementation of the standard at the time of that first-time application, we began to implement an associated project plan in the financial year under review. This included an inventory evaluation of leases of the parent company KSB SE & Co. KGaA and the other Group companies/KSB companies. We have already obtained an overview of the workload and costs involved in the initial compilation of contractual data in a contract management tool designed for that purpose. The analysis of the lease situation that has already begun will be extended in 2018 to include all contracts, and we will also create a questionnaire on IFRS 16 that will have to be completed by every Group company. The results will be used to derive any further system changes required and create guidelines for correctly handling contracts after 1 January 2019. Appropriate changes to the reporting forms and accounting instructions will also be made.

IFRIC 23 Uncertainty over Income Tax Treatment specifies requirements for the recognition and measurement of uncertain income tax items. As part of the assessment of uncertainty, a company needs to evaluate whether it is probable that the tax jurisdiction will accept the treatment of income taxes.

The IASB has revised **IAS 19 Employee Benefits** with regard to plan amendment, curtailment and settlement. As of 1 January 2019, in the event of amendment, curtailment or settlement related to a defined benefit pension plan, the current service cost and the net interest for the remaining financial year are to be determined based on the current actuarial assumptions that were used for the required remeasurement of net liabilities.

IFRS 17 Insurance Contracts stipulates the principles governing the recognition, measurement, presentation and disclosure of insurance contracts within the scope of the standard. The objective is to ensure that the reporting companies provide relevant information that faithfully represents the insurance contracts.

As a matter of principle, we have not voluntarily applied the above-mentioned new or revised Standards or the Interpretation prior to their effective dates. We do not anticipate any, or any material, impact on our net assets, financial position or results of operations.

With regard to IFRS 9 Financial Instruments, IFRS 15 Revenue from Contracts with Customers and IFRS 16 Leases, please refer to the comments in the previous sections.

II. BASIS OF CONSOLIDATION

Consolidated Group

In addition to KSB SE & Co. KGaA, 9 German and 73 foreign companies (previous year: 9 German and 79 foreign companies) were fully consolidated. We hold a majority interest, either directly or indirectly, in the voting power of these subsidiaries which the KSB Group has the option to control under IFRS 10.

The Thai company KSB Pumps Co. Ltd., Bangkok, and the Indian company KSB Pumps Limited, Pimpri (Pune) are includ-

ed in the group of fully consolidated affiliates despite the fact that we hold less than 50 % of the voting rights. We do, however, have the power to determine their business and financial policies and thus the level of variable returns.

Companies that were not consolidated due to there being no material impact are reported under financial assets – other investments.

The following table shows the subsidiaries with non-controlling interests that are material subsidiaries of the KSB Group. “Seat” refers to the country in which the main activity is performed.

→ [Material subsidiaries with non-controlling interests](#)

The summarised financial information regarding the KSB Group’s material subsidiaries with non-controlling interests is provided below. This information corresponds to the amounts given in the subsidiaries’ financial statements prepared in accordance with IFRS prior to intercompany eliminations.

→ [Summarised balance sheet](#)

→ [Summarised statement of comprehensive income](#)

→ [Condensed statement of cash flows](#)

Material subsidiaries with non-controlling interests

Name and seat	Non-controlling interest in capital	Earnings after income taxes attributable to non-controlling interests		Accumulated non-controlling interests	
		2017 / 2016	31 Dec. 2017	31 Dec. 2016	31 Dec. 2017
GIW Industries, Inc., USA	49.0 %	4,191	4,860	28,878	29,927
KSB Pumps Limited, India	59.5 %	4,742	4,889	53,508	53,604
KSB America Corporation, USA	49.0 %	91	245	23,736	25,062
KSB Shanghai Pump Co., Ltd., China	20.0 %	-847	491	10,569	12,150
Individually immaterial fully consolidated subsidiaries with non-controlling interests		6,746	4,349	45,417	43,918
Total amount of non-controlling interests		14,923	14,834	162,108	164,661

Summarised balance sheet

€ thousands / 31 Dec.	GIW Industries, Inc.		KSB Pumps Limited		KSB America Corporation		KSB Shanghai Pump Co., Ltd.	
	2017	2016	2017	2016	2017	2016	2017	2016
Non-current assets	49,366	58,303	48,551	41,469	29,591	35,399	25,398	31,474
Current assets	55,819	62,755	101,760	95,337	54,731	57,686	137,263	149,400
Non-current liabilities	-6,643	-6,899	-5,223	-3,327	-	-	-	-
Current liabilities	-20,173	-33,687	-56,330	-44,527	-25,950	-27,931	-113,214	-127,922
Net assets	78,369	80,472	88,758	88,952	58,372	65,154	49,447	52,952

Summarised statement of comprehensive income

€ thousands	GIW Industries, Inc.		KSB Pumps Limited		KSB America Corporation		KSB Shanghai Pump Co., Ltd.	
	2017	2016	2017	2016	2017	2016	2017	2016
Sales revenue	127,114	134,612	127,563	109,147	-	-	146,291	129,850
Earnings after income taxes	8,554	9,919	8,804	9,026	1,175	4,457	-5,478	2,540
Other comprehensive income	-2,821	2,712	-4,083	-163	-7,957	2,144	7,893	-7,507
Comprehensive income	5,733	12,631	4,721	8,863	-6,782	6,601	2,415	-4,967
Other comprehensive income attributable to non-controlling interests	-1,382	1,329	-2,428	-97	-3,899	1,051	1,579	-1,501
Comprehensive income attributable to non-controlling interests	2,809	6,189	2,807	5,270	-3,323	3,234	483	-993
Dividends paid to non-controlling interests	-	-	-1,549	-1,531	-	-	-	-

Condensed statement of cash flows

€ thousands	GIW Industries, Inc.		KSB Pumps Limited		KSB America Corporation		KSB Shanghai Pump Co., Ltd.	
	2017	2016	2017	2016	2017	2016	2017	2016
Cash flows from operating activities	9,577	23,570	-3,606	7,562	1,670	3,819	9,495	9,660
Cash flows from investing activities	-664	-6,477	-10,354	-8,235	1,638	-	193	-1,112
Cash flows from financing activities	-8,856	-18,072	-2,867	-2,848	2,827	-12,257	-9,121	-11,203
Changes in cash and cash equivalents	57	-979	-16,827	-3,521	6,135	-8,438	567	-2,655
Cash and cash equivalents at beginning of period	180	1,169	28,241	31,707	14,849	22,956	2,292	5,301
Effects of exchange rate changes	-25	-10	-1,150	54	-2,156	332	-301	-355
Cash and cash equivalents at end of period	212	180	10,264	28,240	18,828	14,850	2,558	2,291

KSB Pump & Valve Technology Service (Tianjin) Co., Ltd and KSB PHILIPPINES, INC., previously not consolidated due to there being no material impact, were included in the group of consolidated companies on 1 January 2017. These affiliates, which were consolidated for the first time, were established some years earlier. First-time consolidations contributed € 3,669 thousand to sales revenue and also had the following impact on the consolidated balance sheet:

First-time consolidations – Impact on balance sheet

€ thousands	2017
Non-current assets	-659
Current assets	2,624
Assets	1,965
Equity	-885
Non-current liabilities	-
Current liabilities	2,850
Equity and liabilities	1,965

Other effects resulting from the consolidation of companies were not material.

With effect from 1 January 2017, the previously fully consolidated service companies KSB Service Est S.A.S., Algrange, and Service Centre-Est S.A.S., Villefranche-sur-Saône, were merged with KSB S.A.S. in France, which has its head office in Gennevilliers and is also fully consolidated. The two previously fully consolidated service companies KSB SERVICE MEDIATEC S.A.S., Chalon-sur-Saône, and KSB SERVICE ETC S.A.S., Chalon-sur-Saône, were merged, with effect from 1 January 2017, with Rambervillers-based KSB Service Energie S.A.S.U., which is also fully consolidated.

With effect from 1 January 2017, the previously fully consolidated company KSB Válvulas Ltda., Jundiaí, was merged with KSB BRASIL LTDA., which has its head office in Várzea Paulista (Brazil) and is also fully consolidated.

In China, we had already transferred the foundry operations of KSB Shanghai Pump Co., Ltd., Shanghai, to a new, independent

company (KSB Shanghai Precision Casting Co., Ltd.) in the previous year. 95 % of the interest held in the company, which at the time was classified as being held for sale, was sold within the reporting period, with a remaining share of 5 %.

The Danish company T. Smedegaard A/S, Glostrup and the Chinese company KSB Valves (Shanghai) Co. Ltd., Shanghai, were liquidated in the financial year.

We sold our valves business in the USA, operated KSB AMRI Inc., Houston, in the financial year.

In December 2017 we purchased 51 % of the shares in Pumpen Partner Netzwerk UG. Due to reasons of materiality the company will not be consolidated.

The impact of the above changes on the consolidated financial statements was not material.

A full list of the shareholdings held by the KSB Group is provided at the end of these Notes to the Consolidated Financial Statements.

Consolidation methods

For the purposes of consolidation, the effects of any intercompany transactions are eliminated in full. Any receivables and liabilities between the consolidated companies are offset against each other, and any unrealised gains and losses recognised in fixed assets and inventories are eliminated. Any revenues from intercompany sales are offset against the corresponding expenses.

Capital consolidation uses the purchase method of accounting pursuant to IFRS 3. This means that the acquisition cost of the parent's shares in the subsidiaries is eliminated against the remeasured equity attributable to the parent at the date of acquisition.

Any goodwill created from the application of the purchase method denominated in a currency other than the functional currency of the KSB Group is measured at the relevant current closing rate. Goodwill is reported under intangible assets and tested for impairment at least once a year. If an impairment is

identified, an impairment loss is recognised. Any excess of our interest in the fair values of net assets acquired over cost remaining after reassessment is recognised in profit or loss in the year it occurred.

Those shares of subsidiaries' equity not attributable to KSB SE & Co. KGaA are reported as non-controlling interests.

Currency translation

The consolidated financial statements have been prepared in euros (€). Amounts in this report are presented in thousands of euros (€ thousands) using standard commercial rounding rules.

Currency translation is effected on the basis of the functional currency of the consolidated companies. As in the previous year, the functional currency is exclusively the local currency of the company consolidated, as it operates as a financially, economically and organisationally independent entity.

Transactions denominated in foreign currencies are translated at the individual companies at the rate prevailing when the transaction is initially recognised. Monetary assets and liabilities are subsequently measured at the closing rate. Measurement effects are recognised in the income statement.

When translating financial statements of consolidated companies that are not prepared in euro, assets and liabilities are translated at the closing rate; the income statement accounts and cash flow statement items are translated at average annual exchange rates (modified closing rate method). Gains and losses from the translation of items of assets and liabilities compared with their translation in the previous year are taken directly to

equity in other comprehensive income and reported under currency translation differences. They amount to € –103,914 thousand (previous year: € –49,771 thousand). The effect of currency translation adjustments taken directly to equity on intangible assets, property, plant and equipment, and financial assets was a loss of € 25,689 thousand (previous year: gain of € 8,827 thousand).

→ [Exchange rates for the most important currencies](#)

III. ACCOUNTING POLICIES

Acquisition and production costs

In addition to the purchase price, acquisition cost includes attributable incidental costs (except for costs associated with the acquisition of a company) and subsequent expenditure. Purchase price reductions are deducted from cost.

In addition to direct material and labour costs, production cost includes production-related administrative expenses. General administrative expenses and selling expenses are not capitalised.

Borrowing costs as defined in IAS 23 that can be directly allocated to the acquisition or production of qualifying assets are capitalised from 2009. As in the previous year no such borrowing costs were incurred.

Fair value

Fair value is the price that independent market participants would, under standard market conditions, receive when selling an asset or pay when transferring a liability at the measurement

Exchange rates for the most important currencies

	Closing rate		Average rate	
	31 Dec. 2017	31 Dec. 2016	2017	2016
US dollar	1.1993	1.0541	1.1292	1.1067
Brazilian real	3.9729	3.4305	3.6041	3.8606
Indian rupee	76.6055	71.5935	73.4887	74.3500
Chinese yuan	7.8044	7.3202	7.6257	7.3494

date. This applies irrespectively of whether the price is directly observable or has been estimated using a measurement method.

The KSB Group defined a monitoring framework concept for determining fair value. This includes a measurement team with general responsibility for monitoring all key measurements at fair value and notifying management and, if necessary, the Audit Committee of any major issues. For the purposes of calculating fair value, we make use wherever possible of estimates from market participants or estimates derived from these. In a first step we regularly review the extent to which there are current prices on active markets for identical transactions. If no quoted market prices are available, our preference is to use the market-based approach (deriving the fair value from the market or transaction prices of comparable assets, for example multipliers) or the income-based approach (calculation of fair value as a future value by discounting future cash surpluses).

Based upon the input factors used in the measurement methods, fair values are assigned to different levels of the fair value hierarchy.

- Level 1: Quoted prices (unadjusted) on active markets for identical assets and liabilities
- Level 2: Measurement parameters that are not the quoted prices taken into account for level 1, but that are observable for the asset or the liability either directly as a price or indirectly derived from prices
- Level 3: Measurement parameters for assets or liabilities that are not based on observable market data

If input factors categorised into different levels are included in the fair value measurement, the measurement must be categorised in its entirety in the level of the lowest level input factor that is material for the entire measurement.

We record reclassifications between different levels in the fair value hierarchy at the end of the reporting period during

which the change has occurred. There were no reclassifications carried out in the year under review.

Financial instruments

A financial instrument is any contract that gives rise to both a financial asset of one enterprise and a financial liability or equity instrument of another enterprise.

Financial assets and financial liabilities are recognised in the consolidated balance sheet at the time when KSB becomes a party to a financial instrument. When the contractual right to payments from financial assets expires, these are derecognised. Financial liabilities are derecognised at the time when the contractual obligations are settled or cancelled or have expired. Regular way purchases and sales of financial instruments are recognised at their value at the settlement date; only derivatives are recognised at their value at the trade date. This applies to primary financial instruments such as trade receivables and monetary receivables, as well as to trade payables and financial liabilities (from or to third parties as well as affiliates and equity investments).

a) Primary financial instruments

Within the KBS Group, primary financial instruments are allocated to the following categories as financial assets or liabilities:

- Loans and Receivables (LaR)
Loans and financial assets not quoted in an active market
- Financial Liabilities Measured at Amortised Cost (FLAC)
Liabilities that are not quoted in an active market, such as trade payables
- Available-for-Sale (Afs) financial assets
Non-derivative financial instruments that are not allocated to any other measurement category, such as investments in non-consolidated subsidiaries or securities

None of our financial instruments are classified as “held-to-maturity investments”.

Financial instruments are carried at fair value on initial recognition, while LaR and FLAC take into account the transaction costs. Subsequent measurement is based on fair value for category AfS and on amortised cost for categories LaR and FLAC. Subsequent measurement of the LaR and FLAC categories is based on amortised cost using the effective interest method. The fair values of the current and non-current financial instruments are based on prices quoted in active markets on the reporting date.

Primary financial instruments classified as “available-for-sale financial instruments” are recognised directly in equity in other comprehensive income and reported under “Changes in the fair value of financial instruments”. They are recognised in profit or loss when the assets are sold or deemed to be other-than-temporarily impaired. If an asset is derecognised, the accumulated other comprehensive income is reclassified to the income statement.

As in the previous year, we did not make any reclassifications between the individual measurement categories.

We do not currently make use of the fair value option.

b) Derivative financial instruments

We only use derivatives for hedging purposes. We hedge both future cash flows and existing recognised underlyings against foreign currency and interest rate risks (cash flow hedges). The hedging instruments used are exclusively currency forwards, currency options and interest rate derivatives entered into with prime-rated banks. We hedge currency risks primarily for transactions in US dollars (USD). Interest rate risks are minimised for long-term borrowings at floating rates of interest. Group guidelines govern the use of these instruments. These transactions are also subject to continuous risk monitoring.

In the case of cash flow hedges, changes in the fair value of the effective portions of the currency derivatives are recognised under other comprehensive income and reported under “Changes in the fair value of financial instruments” in equity for as long as the underlying transaction is not recognised in the income statement.

Changes in the market value of interest rate derivatives used to hedge against interest rate risks in liabilities are recognised under other comprehensive income and reported under “Changes in the fair value of financial instruments” in equity.

The carrying amounts equal fair value and are determined on the basis of input factors observable either directly (as a price) or indirectly (derived from prices). Fair values may be positive or negative. Fair value is the amount that we would receive or have to pay at the reporting date to settle the financial instrument. This amount is determined using the relevant exchange rates, interest rates and counterparty credit ratings at the reporting date. All our information is obtained from recognised external sources.

Currency forwards and interest rate swaps are reported under other receivables and other current assets, and under miscellaneous other liabilities.

As in the previous year, maturities of the currency derivatives used are mostly between one and two years; there are no interest rate derivatives for the financial year in the Group. The maturities of the hedging instruments are matched to the period in which the forecast transactions are expected to occur. In the year under review, almost all hedged forecast transactions occurred as expected.

Intangible assets

Intangible assets are carried at (acquisition or production) cost and reduced by straight-line amortisation. Depreciation/amortisation is reported under “Depreciation and amortisation expense” in the income statement. The underlying useful lives of intangible assets – excluding goodwill (indefinite useful life) – is between two and five years. If the reasons for an impairment loss in a previous period no longer apply, it is reversed (write-up) up to a maximum of amortised cost.

We test goodwill for impairment once a year. This relates to cash-generating units (CGU), which at KSB are generally the legal entities. Occasionally a group of cash-generating units may also serve as the basis, provided these units reflect the lowest level on which we monitor goodwill. The goodwill (and, if necessary, other assets) is reduced by the difference in value if the recoverable amount – the higher of the fair value less costs to sell and the value in use – is lower than the carrying amount of the CGU. Reversal of an impairment loss from an earlier period is not possible. In addition, a review of impairment is always carried out when events or circumstances (“trigger events”) suggest that the value could be impaired.

We apply the discounted cash flow model to determine the recoverable amount (value in use). The future earnings (EBIT in accordance with IFRS) applied were taken from a multi-year financial plan (generally covering a maximum of five years), the basis of which was adopted in December taking into account the medium-term strategy approved by management for the respective cash-generating unit. We carried out this planning based on certain assumptions which were drawn from both forecasts from external sources, e.g. current German Engineering Federation (VDMA) publications, and our own experience-based knowledge of markets and competitors. In our calculations we consistently extrapolated the result of the last plan year as a constant, considering that level to be achievable in the long term. We derived growth rates taking account of the rate of inflation and estimates with regard to regional and seg-

ment-specific circumstances. The Group regularly tests goodwill for impairment in the fourth quarter based on the figures as per 30 September of the year in question.

As part of the assessment, the Group conducts sensitivity analyses to estimate the risk of impairment. The following assumptions are used in the process: a 5 % increase in the cost of capital (Sensitivity 1), a 0.25 % reduction in the growth rate (Sensitivity 2) and a reduction in sales revenue with the corresponding impact on expense items and performance indicators (Sensitivity 3). Sensitivity 3 is only applied to the most important goodwills of the KSB Group.

If the recoverable amount is calculated as the fair value less costs to sell, the costs to sell are, based on past experience, set at a maximum of 2 % of the fair value. For the purposes of calculating value, we make use wherever possible of estimates from market participants (Level 1) or estimates derived from these (Level 2). In the absence of any market estimates, we make use of experience-based assumptions of the management (Level 3). In a first step we review the extent to which there are current prices on active markets for identical transactions. If no quoted market prices are available, our preference is to use the market-based approach (deriving the fair value from the market or transaction prices of comparable assets, for example multipliers) or the income-based approach (calculation of fair value as a future value by discounting future cash surpluses).

When acquiring companies we apply purchase price allocations and determine the fair value of the assets and liabilities acquired. In addition to the assets and liabilities already recognised by the selling party, we also assess marketing-related aspects (primarily brands or trademarks and competitive restrictions), customer-related aspects (primarily customer lists, customer relations and orders on hand), contract-related aspects (mainly particularly advantageous service, work, purchasing and employment contracts) as well as technology-related aspects (primarily patents, know-how and databases). To

determine values we primarily apply the residual value method, the excess earnings method and cost-oriented procedures.

Development costs are capitalised as internally generated intangible assets at cost where the criteria described in IAS 38 are met and reduced by straight-line amortisation at the time of their capitalisation. Research costs are expensed as incurred. Where research and development costs cannot be reliably distinguished within a project, no costs are capitalised.

Property, plant and equipment

In accordance with IAS 16, property, plant and equipment is carried at cost and reduced by straight-line depreciation over its useful life. If an asset's recoverable amount is lower than its carrying amount, an impairment loss is recognised. If the reasons for an impairment loss recognised in a previous period no longer apply, the impairment loss is reversed (write-up) up to a maximum of amortised cost.

Government grants relating to property, plant and equipment are transferred to an adjustment item on the liabilities side. This adjustment item is reversed over a defined utilisation period. As far as government grants recognised which are to be held for specific periods of time are concerned, we expect that these periods will be complied with.

Maintenance expenses are recognised as an expense in the period in which they are incurred, unless they lead to the expansion or material improvement of the asset concerned.

The following useful lives are applied:

Useful lives of property, plant and equipment

Buildings	10 to 50 years
Plant and machinery	5 to 25 years
Other equipment, operating and office equipment	3 to 25 years

Leases

IAS 17 defines a lease as an arrangement under which a lessor provides a lessee with the right to use an asset for an agreed period of time in exchange for a payment. A lease is classified as a finance lease if it transfers substantially all the risks and rewards incident to ownership to the lessee. Otherwise, such transactions are classified as operating leases.

Lease payments that are payable under operating leases are recognised as expenses in the period in which they are incurred. In the case of finance leases, the leased asset is recognised at the time of inception of the lease at the lower of fair value and the present value of future minimum lease payments. A liability is recognised in the same amount for the future lease payment. The asset's carrying amount is reduced by depreciation over its useful life or the shorter lease term.

Non-current financial assets

Interest-bearing loans and investments in non-consolidated subsidiaries are measured at amortised cost. Financial instruments are carried at their fair values at the reporting date.

Investments accounted for using the equity method

Investments accounted for using the equity method are companies in which the parties exercise joint control (joint venture) or have the power to exercise significant influence over the companies' operating and financial policies (associate); this is usually the case where an entity holds between 20 % and 50 % of the voting power. These assets are recognised at cost at the time of acquisition. If the costs of acquisition exceed the share of the net assets, adjustments are made on the basis of the fair value (pro rata hidden reserves and liabilities). The remaining amount is recorded as goodwill. It forms part of the carrying amount of the joint venture or associate and is not amortised. For subsequent measurement, the carrying amounts are increased/reduced annually by the pro-rata earnings, distributed dividends or other changes in equity of the joint venture or the

associate. If local accounting principles differ from the accounting methods used in the Group, we make the necessary adjustments. The share of earnings is reported in the consolidated income statement in a separate line (earnings from investments accounted for using the equity method), and changes such as currency translation effects are taken directly to Group equity. If the losses attributable to the KSB Group correspond to the carrying amount of the company or exceed this, they are not recognised unless KSB has entered into obligations or has made payments for the company. Intercompany gains and losses from transactions between Group companies and investments accounted for using the equity method are offset against the carrying amount in profit or loss. At each reporting date we review whether there are any objective indications of impairment, and calculate the amount of such impairment if required. If the carrying amount exceeds the recoverable amount of an investment, it is written down to the recoverable amount. Any impairments or reversals of impairments are reported in the consolidated income statement under financial income/expense.

Inventories

Pursuant to IAS 2, inventories are carried at the lower of cost and net realisable value as at the reporting date. Cost is measured using the weighted average method. Write-downs to the net realisable value take account of the inventory risks resulting from slow-moving goods or impaired marketability. This also applies if the selling price is lower than production cost plus costs still to be incurred. If the reasons for an impairment loss charged in a previous period no longer apply, the impairment loss is reversed (write-up).

Advance payments made on inventories are also presented here because of the correlation and expected realisation of these advances (through conversion into inventories) within the normal business cycle. Advances received from customers are recognised as current liabilities.

Construction contracts under IAS 11

In the case of construction contracts covered by IAS 11, we apply the percentage of completion (PoC) method. According to this method, a production order is a contract for the customer-specific production of individual items or a number of items that, in terms of their design, technology and function or with regard to their use, are linked to one another or dependent on each other. If the earnings from a production order can be reliably estimated, we recognise the revenue based on the percentage of completion method. The percentage of completion of contracts is determined on the basis of the proportion that contract costs incurred for work performed up to the reporting date bear to the estimated total contract costs at the reporting date. Contract revenue consists of all contractually agreed revenues, as well as additional claims and incentive payments that are likely to result in revenue and are capable of being reliably measured. Contract revenue may vary from one period to the next, for instance because of cost escalation clauses, variations or penalties. It is measured at the fair value received or receivable. If the earnings from a production order cannot be reliably estimated, revenue will only be recognised in the amount of the contract costs incurred that are likely to be covered and the contract costs recognised as an expense for the period in which they are incurred.

The percentage contract revenue less the related advances received from customers is reported – depending on the balance – in trade receivables and PoC or within other financial liabilities. Effects in the period are recognised in the income statement as part of sales revenue.

Trade receivables and other current assets

Trade receivables and other current assets are subsequently carried at amortised cost. Low-interest or non-interest-bearing receivables are discounted. In addition, we take account of identifiable risks by charging specific write-downs using allowance accounts. Receivables that are not individually impaired are subdivided into risk classes according to how overdue they

are, and written down on a portfolio basis using historical default rates. If the reasons for an impairment loss charged in a previous period no longer apply, the impairment loss is reversed (write-up).

We hedge part of the credit risk exposure of our receivables (for further explanations, refer to the Financial Risks – Credit Risk section).

The prepaid expenses reported relate to accrued expenditure prior to the reporting date that will only be classified as an expense after the reporting date.

Cash and cash equivalents

Cash (cash and sight deposits) and cash equivalents (short-term, highly liquid financial investments that are readily convertible to defined amounts of cash, and that are subject to only immaterial fluctuations in terms of their value) are recognised at amortised cost.

Assets held for sale

Pursuant to IFRS 5, non-current assets or disposal groups are classified as held for sale if it is highly likely that the carrying amount will be realised primarily by a sales transaction and not through continued use of that asset. It must be assumed that the sale will be completed within one year. If the Group is committed to a sale that involves loss of control of a subsidiary, all assets and liabilities of that subsidiary will be classified as held for sale, provided the above conditions are met. The intangible assets and property, plant and equipment of the held-for-sale assets are no longer amortised/depreciated, but instead are recognised at the lower of the carrying amount and fair value less costs to sell.

Deferred taxes

We account for deferred taxes in accordance with IAS 12 using the balance sheet liability method on the basis of the enacted or substantively enacted local tax rates. This means that deferred tax

assets and liabilities generally arise when the tax base of assets and liabilities differs from their carrying amount in the IFRS financial statements, and this leads to future tax expense or income. We also recognise deferred tax assets from tax loss carryforwards in those cases where it is more likely than not that there will be sufficient taxable profit available in the near future against which these tax loss carryforwards can be utilised. Deferred taxes are also recognised for consolidation adjustments. Deferred taxes are not discounted. Deferred tax assets and liabilities are always offset where they relate to the same tax authority. Changes to deferred taxes in the consolidated balance sheet generally result in deferred tax expense or income. If, however, a direct entry is made in other comprehensive income in equity, the change in deferred taxes is also taken directly to equity.

Provisions

a) Provisions for pensions and similar obligations

Provisions for pensions and similar obligations pursuant to IAS 19 are calculated on the basis of actuarial reports. They are based on defined benefit pension plans. They are measured using the projected unit credit method.

Actuarial gains and losses are taken directly to other comprehensive income and reported in equity under “Remeasurement of defined benefit plans”. The actuarial demographic assumptions and the setting of the discount rate (based on senior, fixed-income corporate bonds) and other measurement parameters (for example income and pension trends) are based on best estimates.

Net interest is calculated by multiplying the discount rate with the net liability (pension obligation minus plan assets) or the net asset value that results if the plan assets exceed the pension obligation.

The defined benefit costs include the service cost, which is included in staff costs under pension costs, and the net interest income or expense on the net liability or net realisable value,

which is recognised in financial income/expense under interest and similar expenses or under interest and similar income.

KSB companies that use a defined contribution pension plan do not recognise provisions. The premium payments are recognised directly in the income statement as pension costs in the staff costs. Other than an obligation to pay premiums, these companies have no further obligations. Consequently, the insurance risk remains with the insured parties.

b) Other provisions

Provisions are recognised if a past event results in a present legal or constructive external obligation that the company has no realistic alternative to settling, where settlement of this obligation is expected to result in an outflow of resources embodying economic benefits, and the amount of the obligation can be estimated reliably. The amount of the provision corresponds to the best estimate of the settlement amount of the current obligation on the reporting date. Any more or less secure recourse or reimbursement claims are recognised as separate assets.

Provisions for restructurings are recognised only if the criteria set out in IAS 37 are met.

Non-current provisions are discounted if the effects are material.

Financial liabilities

Financial liabilities are recognised with their amortised costs using the effective interest rate method.

Contingent liabilities (contingencies and commitments)

Contingent liabilities, which are not recognised, are possible obligations that arise from past events and whose existence will be confirmed only by the occurrence or non-occurrence of uncertain future events. Contingent liabilities may also be pres-

ent obligations that arise from past events where it is possible but not probable that there will be an outflow of resources embodying economic benefits.

Contingent liabilities correspond to the extent of liability at the reporting date.

Income and expenses

Sales revenue consists of charges for deliveries and services billed to customers. This relates to revenue from the sale of goods and goods purchased and held for resale from the production, sale and trade of machinery, systems and other industrial products, particularly pumps and valves. In addition, sales revenue from services and licence income is reported under sales revenue for the period concerned in accordance with the economic content of the underlying contract. Sales revenue is recognised pursuant to IAS 18 when the deliveries have been effected or the services have been rendered and the significant risks and rewards associated with ownership have thus been transferred to the customer. At the time of revenue recognition, receipt of the consideration must be probable and the amount of sales revenue must be reliably measurable. A reliable estimation of the associated costs and potential return of the goods must also be possible. We essentially recognise sales revenue from the delivery of standard products upon handover to the carrier. For some international deliveries, the contractual risk transfer takes place when the goods are loaded onto a cargo ship in the port or delivered to the customer in the destination country. In these cases, sales revenue is recognised on the basis of the contractually agreed INCOTERMS. For certain deliveries and services, a declaration of acceptance by the customer is required for the recognition of sales revenue.

In individual cases and under strict conditions, sales revenue is recognised prior to delivery of the goods (so-called bill and hold arrangements).

Sales revenue for customer-specific construction contracts is reported using the percentage of completion method. We use the so-called cost-to-cost method, according to which the proceeds determined at the beginning of the sales order are compared with the estimated costs, and the sales revenue of a period is determined according to the percentage of completion measured on the basis of the costs incurred; see the explanations on “Construction contracts under IAS 11”.

Sales allowances reduce sales revenue.

Interest income and expense are recognised in the period in which they occur.

Dividend income from investments is collected when the legal entitlement to payment is created.

Operating expenses are recognised when they are incurred or when the services are utilised.

Income taxes are calculated in accordance with the statutory tax rules in the countries in which the Group operates. Deferred taxes are accounted for on the basis of the enacted or substantively enacted income tax rates.

Estimates and assumptions

The preparation of consolidated financial statements in accordance with the IFRSs as adopted by the EU requires management to make estimates and assumptions that affect the accounting policies to be applied. When implementing such accounting policies, estimates and assumptions affect the assets, liabilities, income and expenses recognised in the consolidated financial statements, and their presentation. These estimates and assumptions are based on past experience and a variety of other factors deemed appropriate under the circumstances. Actual amounts may differ from these estimates and assumptions. We continu-

ously review the estimates and assumptions that we apply. If more recent information and additional knowledge are available, recognised amounts are adjusted to reflect the new circumstances. Any changes in estimates and assumptions that result in material differences are explained separately.

Impairment tests for goodwill, which are conducted at least once per year, require an estimate of the recoverable amounts for each cash-generating unit (CGU). These correspond to the higher amount from the fair value less costs to sell and value in use. The earnings forecast on the basis of these estimates are affected by various factors, which may include exchange rate fluctuations, progress in Group integration or the expectations for the economic development of these units. Although management believes that the assumptions used to calculate the recoverable amount are appropriate, any unforeseen changes in these assumptions could lead to an impairment loss.

Estimates and assumptions must also be made to review the *value of assets*. For each asset it must be verified to what extent there are indications of an impairment. When determining the recoverable amount of property, plant and equipment, the estimation of the relevant useful life is subject to uncertainty. The measurement of doubtful receivables is based on forecasts about the creditworthiness of customers. A material change in the assumptions or circumstances can lead in future to additional impairment losses or reversals.

For *construction contracts with clients in the project business* we recognise sales revenue according to the percentage of completion method. This requires estimates regarding the total contract costs and revenue, contract risks as well as other relevant factors. These estimates are reviewed regularly by those with operative responsibility and adjusted where necessary.

Provisions for employee benefits, especially pensions and similar obligations, are determined according to actuarial principles which are based on statistical and other factors so as to anticipate future events. Material factors are the reported market discount rates and life expectancy. The actuarial assumptions made may differ from actual developments as a result of changing market and economic conditions, and this can have material effects on the amount of provisions and thus on the company's overall net assets, financial position and results of operations.

Other provisions are reported based on the best possible estimate of the probability of future outflows. The later, actual outflow can, however, differ from the estimate as a result of changed economic, political or legal conditions. This will be reflected in additional expenses or income from reversals.

The global scope of our activities must be taken into account in relation to *taxes on income*. Based on our operative activities in numerous countries with varying tax laws and administrative interpretation, differentiated assessment is required for determining our tax obligations. Uncertainty may arise due to different interpretations by taxable entities on the one hand and local finance authorities on the other. Uncertain tax assets and liabilities are recognised if their probability of occurrence exceeds 50%. For the reporting, the best estimate is based on the expected tax payment. Although we believe we have made a reasonable

estimate regarding any tax uncertainties, it is possible that the actual tax obligation will differ from our original estimate. With regard to future tax benefits, we assess their realisability as of every reporting date. For this reason, we only recognise deferred tax assets if sufficient taxable income is available in future. In assessing this future taxable income within a planning horizon of normally five years it must be taken into account that expected future business developments are subject to uncertainties and are in some cases excluded from control by company management (for example changes to applicable tax legislation). If we come to the conclusion that previously reported deferred tax assets cannot be realised because of changed assumptions, then the assets will be written down by the appropriate amount.

Maturities

Maturities of up to one year are classified as current.

Assets that can only be realised after more than 12 months, as well as liabilities that only become due after more than 12 months, are also classified as current if they are attributable to the operating cycle defined in IAS 1. An operating cycle of more than 12 months typically applies to made-to-order production (construction contracts).

Assets and liabilities not classified as current are non-current.

IV. BALANCE SHEET DISCLOSURES

1 Intangible assets

Statement of changes in intangible assets

€ thousands	Concessions, industrial property and similar rights and assets, as well as licences in such rights and assets		Goodwill		Advance payments		Intangible assets Total	
	2017	2016	2017	2016	2017	2016	2017	2016
Historical cost								
Balance at 1 January	71,167	61,708	104,189	103,910	15,781	8,550	191,137	174,168
Changes in consolidated Group	28	2	–	135	–	–	28	137
Currency translation adjustments	–2,014	700	–813	482	–	–	–2,827	1,182
Other	–6	6,502	–	–338	–	–	–6	6,164
Additions	2,767	2,519	–	–	9,692	7,520	12,459	10,039
Disposals	285	726	166	–	–	14	451	740
Reclassifications	226	1,061	–	–	–162	–275	64	786
Reclassification to assets held for sale	–	–599	–	–	–	–	–	–599
Balance at 31 December	71,883	71,167	103,210	104,189	25,311	15,781	200,404	191,137
Accumulated depreciation and amortisation								
Balance at 1 January	57,294	51,032	27,247	21,061	–	–	84,541	72,093
Currency translation adjustments	–1,441	605	–132	46	–	–	–1,573	651
Other	–6	2,089	–1	–338	–	–	–7	1,751
Additions	4,114	4,447	5,556	6,478	–	–	9,670	10,925
Disposals	281	650	–	–	–	–	281	650
Reclassifications	–	–	–	–	–	–	–	–
Reclassification to assets held for sale	–	–229	–	–	–	–	–	–229
Balance at 31 December	59,680	57,294	32,670	27,247	–	–	92,350	84,541
Carrying amount at 31 December	12,203	13,873	70,540	76,942	25,311	15,781	108,054	106,596

The additions to intangible assets amounting to € 12.5 million (previous year: € 10.0 million) primarily concerned, as in the previous year, advance payments and own work capitalised for a new software to be deployed in Sales.

As in the previous year, we did not capitalise any development costs in the financial year because not all of the comprehensive recognition criteria defined in IAS 38 were met. The “Concessions, industrial property and similar rights and as-

sets, as well as licences in such rights and assets” item includes € 8.3 million (previous year: € 9.3 million) of software including software licences valid for a limited period. As in the previous year, there are no restrictions on ownership or use.

The carrying amounts of the cash-generating units in connection with the impairment testing of goodwill do not contain any items relating to taxes or financing activities.

To determine the discount factor, the weighted average cost of capital (WACC) method is applied in conjunction with the capital asset pricing model (CAPM), taking into account a peer group. Under this method, first the cost of equity is determined using CAPM and the borrowing costs are defined, and then the individual capital components are weighted in accordance with the capital structure taking account of the peer group. This peer group information includes things like beta factors, capital structure data and borrowing costs. The peer group includes companies that are similar to the KSB Group in terms of industry, size and activity. To account for changes in market parameters, the composition of the peer group is reviewed at regular intervals and adjusted if necessary (e.g. changes in the business model of either the company, the cash-generating unit or the comparable company being looked at). This year’s review resulted in an adjustment of the peer group.

The interest rate for risk-free 30-year Bunds was used as a base rate. This rate was 1.25 % in the year under review (previous year: 0.5 %). The market risk premium was set at 5.75 %, which was unchanged on the previous year, with a beta factor of 0.94 (previous year: 1.06). In addition, country-specific tax rates and country risk premiums are taken into account individually for each cash-generating unit (CGU). As in the previous year, we applied growth rates of between 0.75 % and 1.25 %.

Discount rates

Before taxes in % (value in use)	2017	2016
Companies in Germany	8.7 – 8.8	8.5 – 8.6
Companies in The Netherlands	8.3	8.1
Companies in the USA	9.7	9.1
Companies in South Africa	12.2	12.8
Companies in the rest of Europe	8.2 – 13.8	8.3 – 14.5
After taxes in % (fair value less costs to sell)		
Companies in South Korea	7.3	7.3

Goodwill

Name of CGU / € thousands	31 Dec. 2017	31 Dec. 2016
KSB Seil Co., Ltd., South Korea	21,665	27,432
DP industries B.V., The Netherlands	18,285	18,285
Société de travaux et Ingénierie Industrielle (ST II), France	5,689	5,689
Dynamik-Pumpen GmbH, Germany	3,150	3,150
Uder Elektromechanik GmbH, Germany	2,980	2,980
KSB Finland Oy, Finland	2,603	2,603
KSB Pumps (S.A.) (Pty) Ltd., South Africa	2,010	2,059
KSB SERVICE ETC S.A.S., France*	1,412	1,412
	57,794	63,610
Other 16 (previous year: 16) companies	12,746	13,332
Total	70,540	76,942

* Merged with KSB Service Energie S.A.S.U. in the financial year

As part of the regular review, the peer group was adjusted based on updated findings regarding the business models of the comparable companies. The change in the peer group also resulted in a change to the weighted capital cost factor. The adjustment only had a material impact on the goodwill of KSB Seil Co., Ltd., Busan, South Korea, with a change in the discount factor after taxes from 7.9 % to 7.3 %.

→ Impairment loss on goodwill

Impairment loss on goodwill

Name of CGU	Segment	Discount factor	Recoverable amount € thousands	Impairment loss € thousands
KSB Seil Co. Ltd., Busan, South Korea	Valves	7.3 %	41,662	5,556
Total 31 Dec. 2017				5,556
REEL s.r.l., Italy	Pumps	13.5 %	2,412	5,526
KSB, Inc. – Western Division (USA)	Service	9.1 %	–	952
Total 31 Dec. 2016				6,478

According to an assessment by management, the impairment of the cash-generating unit was the result of a significant delay in the recovery in the shipbuilding market that was longer than forecast in previous years. The impairment loss will be reported in the income statement under “Depreciation and amortisation expense”.

Detailed information on key goodwill items

Cash-generating unit	Method	Carrying amount of goodwill € millions	Percentage of total goodwill	Discount rate	Growth rate	Underlying assumptions, corporate planning	Method for assessing the value of the underlying assumption
KSB Seil Co., Ltd.	Fair value less costs to sell (costs to sell of €250 thousand)	21.7	31 %	7.3 % after taxes	1.00	<ul style="list-style-type: none"> ■ Slower recovery in the shipbuilding sector than expected ■ Little change in exchange rates 	Consideration of macro-economic key data and external market research
DP industries B.V.	Value in use	18.3	26 %	8.3 % before taxes	1.25	<ul style="list-style-type: none"> ■ Low to significant market growth rates 	Consideration of macro-economic key data and internal estimates of the relevant purchasing and sales departments

Basic assumptions for goodwill considered material

Cash-generating unit	Order intake	Sales revenue	EBIT	Planning time horizon
KSB Seil Co., Ltd.	Slowly improving growth, on average	Slowly improving growth, on average	Slowly improving growth, on average, as a result of sales revenue and cost planning	7 years
DP industries B.V.	Constant growth, on average	Constant growth, on average	Moderate growth, on average, as a result of sales revenue and cost planning	5 years

For the annual impairment test, the assumptions presented in the “Basic assumptions for goodwill considered material” table were made regarding the development of order intake, sales revenue and operating earnings for goodwill deemed to be material.

→ Basic assumptions for goodwill considered material

The business performance of KSB Seil Co., Ltd. is closely linked to the economic development of the long-cycle shipbuilding industry. This is also documented in the market development studies from external sources we used, which contain forecasts for the next seven years. Correspondingly, we have selected a monitoring period of seven years instead of our commonly used five-year period for impairment testing of this cash-generating unit.

For the purposes of calculating the fair value less costs to sell of the South Korean KSB Seil Co., Ltd., the input factors used for the discounted cash flow method are largely based on ob-

servable market data (base interest rate) or freely accessible information (for example sovereign risk classification, tax rates, procurement prices, sales prices, market studies).

As well as impairment testing, sensitivity analyses were conducted for each cash-generating unit. These only increased the impairment loss for KSB Seil Co., Ltd. (Sensitivity 1: € 7.5 million; Sensitivity 2: € 6.6 million; Sensitivity 3: € 8.0 million). No additional impairment loss would have resulted for a further cash-generating unit.

Before adjusting the peer group, an impairment loss of € 10.4 million would have been incurred (Sensitivity 1: € 13.8 million, Sensitivity 2: € 11.5 million, Sensitivity 3: € 11.4 million); this would have primarily affected KSB Seil Co. Ltd. (South Korea).

As in the previous year, we did not recognise any impairment losses on other intangible assets in the reporting year.

2 Property, plant and equipment

Statement of changes in property, plant and equipment

€ thousands	Land and buildings		Plant and machinery		Other equipment, operating and office equipment		Advance payments and assets under construction		Property, plant and equipment Total	
	2017	2016	2017	2016	2017	2016	2017	2016	2017	2016
Historical cost										
Balance at 1 January	372,075	344,473	583,604	551,208	215,203	212,750	31,049	53,791	1,201,931	1,162,222
Changes in consolidated Group	149	10	605	12	132	102	–	–	886	124
Currency translation adjustments	–13,032	5,482	–20,397	6,873	–7,892	2,878	–1,813	92	–43,134	15,325
Other	–68	6	–2,073	–	2,586	–8	–	–	445	–2
Additions	18,226	10,888	29,041	21,113	21,762	16,599	20,402	23,554	89,431	72,154
Disposals	3,989	529	10,596	12,165	10,972	17,789	23	156	25,580	30,639
Reclassifications	8,226	19,651	12,970	23,921	4,284	1,874	–25,544	–46,232	–64	–786
Reclassification to assets held for sale	–	–7,906	–	–7,358	–	–1,203	–	–	–	–16,467
Balance at 31 December	381,587	372,075	593,154	583,604	225,103	215,203	24,071	31,049	1,223,915	1,201,931
Accumulated depreciation and amortisation										
Balance at 1 January	153,019	146,566	394,668	372,554	152,638	149,271	–	–	700,325	668,391
Currency translation adjustments	–3,962	801	–11,936	4,266	–5,449	2,286	–	–	–21,347	7,353
Other	–603	–	–2,161	2	2,641	–40	–	–	–123	–38
Additions	10,466	8,832	31,910	34,178	18,547	18,657	–	–	60,923	61,667
Disposals	2,132	273	9,581	11,201	10,364	16,600	–	–	22,077	28,074
Reclassifications	–333	–	–796	–	1,129	–	–	–	–	–
Reclassification to assets held for sale	–	–2,907	–	–5,131	–	–936	–	–	–	–8,974
Balance at 31 December	156,455	153,019	402,104	394,668	159,142	152,638	–	–	717,701	700,325
Carrying amount at 31 Dec.	225,132	219,056	191,050	188,936	65,961	62,565	24,071	31,049	506,214	501,606

Assets resulting from finance leases are recognised as fixed assets in accordance with IAS 17, and corresponding financial liabilities are recognised. The carrying amount of these capitalised assets amounts to € 1,382 thousand (previous year: € 2,022 thousand), of which € 429 thousand (previous year: € 918 thousand) relate to land and buildings, € 13 thousand (previous year: € 123 thousand) to plant and machinery and € 940 thousand (previous year: € 981 thousand) to other equipment, operating and office equipment.

In December 2017, 95 % of the interest in the Chinese company KSB Shanghai Precision Casting Co., Ltd., Shanghai (Pumps segment) was sold, with a remaining share of 5 %.

The property of our Australian company classified as held for sale in the previous year, which is assigned to the Pumps segment, was sold in the second half of 2017.

We also divested the valves business of the US company KSB AMRI, Inc., Houston, in late January 2017.

Income from the sale of assets and liabilities presented as held for sale in the previous year totalled € 9.3 million and were recognised in other income. Of that, € 1.3 million relate to KSB Shanghai Precision Casting Co., Ltd., Shanghai, € 5.3 million to the property in Australia and € 2.7 million to the valves business of the US company KSB AMRI, Inc., Houston, Texas.

Disposals of intangible assets and items of property, plant and equipment resulted in book gains of € 12,319 thousand (previous year: € 1,478 thousand) and book losses of € 3,169 thousand (previous year: € 1,270 thousand). The book gains and losses are reported in the income statement under other income and other expenses.

We did not recognise any impairment losses on property, plant and equipment (previous year: € 3.757 thousand).

3 Non-current financial assets

€ thousands	31 Dec. 2017	31 Dec. 2016
Other investments	2,985	5,401
Non-current financial instruments	657	667
Loans	2,490	2,458
	6,132	8,526

Other investments are investments in non-consolidated affiliates that were not consolidated due to there being no material impact. Write-downs on other investments amounted to € 850 thousand (previous year: none). € 186 thousand of the loans are loans to equity investments (previous year: none).

4 Investments accounted for using the equity method

The table below lists the KSB Group's material joint ventures. "Seat" refers to the country in which the main activity is performed. All joint ventures and associates are accounted for using the equity method and can also be found in the list of shareholdings in these Notes to the Consolidated Financial Statements. The share of capital corresponds to the share of voting rights.

→ [Material joint ventures](#)

Neither of the two joint ventures included in the table below is listed on a stock market; there is therefore no available active market value.

Summarised financial information on the material joint ventures of the KSB Group is provided below.

→ [Summarised balance sheet](#)

→ [Summarised statement of comprehensive income](#)

→ [Reconciliation to carrying amount of group share in joint ventures](#)

→ [Summarised information on joint ventures that are immaterial individually](#)

Material joint ventures

Name and seat	Capital share	Nature of the entity's relationship
KSB Pumps Arabia Ltd., Saudi Arabia	50.00 %	KSB Pumps Arabia Ltd. in Riyadh, Saudi Arabia, offers a wide range of services and activities for the energy market as well as in water, waste water and building services applications. The portfolio includes business development and marketing, supply chain management, production of pressure booster systems and pump sets, sale of pumps, valves and systems and technical service activities. KSB Pumps Arabia Ltd. is important for the growth of the Group in the Saudi Arabian market.
Shanghai Electric-KSB Nuclear Pumps and Valves Co., Ltd., China	45.00 %	Shanghai Electric-KSB Nuclear Pumps and Valves Co., Ltd. in Shanghai, China, produces suitable auxiliary pumps for the secondary coolant circuits and modern reactor coolant pumps for the primary cooling circuits of nuclear power stations. Shanghai Electric-KSB Nuclear Pumps and Valves Co., Ltd. is a strategic partnership on the part of the Group, through which KSB is participating in the expansion of energy capacity in China and other Asian markets.

Summarised balance sheet

€ thousands	KSB Pumps Arabia Ltd.		Shanghai Electric-KSB Nuclear Pumps and Valves Co., Ltd.	
	31 Dec. 2017	31 Dec. 2016	31 Dec. 2017	31 Dec. 2016
Non-current assets	9,958	4,051	79,251	90,404
Current assets	36,141	43,248	102,249	86,062
of which cash and cash equivalents	157	5,093	7,116	7,569
Non-current liabilities	-4,619	-7,583	-35,836	-39,238
of which non-current financial liabilities (excluding trade payables and provisions)	-3,334	-6,336	-	-
Current liabilities	-26,193	-20,779	-116,777	-107,448
of which current financial liabilities (excluding trade payables and provisions)	-4,989	-3,650	-37,227	-40,649
Net assets	15,287	18,937	28,887	29,780

Summarised statement of comprehensive income

€ thousands	KSB Pumps Arabia Ltd.		Shanghai Electric-KSB Nuclear Pumps and Valves Co., Ltd.	
	2017	2016	2017	2016
Sales revenue	39,056	38,387	53,331	29,841
Depreciation / amortisation	590	290	4,223	3,758
Interest income	11	-	35	18
Interest expense	-608	-418	-2,617	-2,833
Earnings from continuing operations	1,872	3,074	1,569	-6,164
Taxes on income	-680	-1,109	-592	-934
Earnings after taxes from continuing operations	1,192	1,965	977	-7,098
Earnings after taxes from discontinued operations	-	-	-	-
Other comprehensive income	-2,941	549	-1,870	-1,384
Comprehensive income	-1,749	2,514	-893	-8,482
Dividends received from joint ventures	951	1,969	-	-

Reconciliation to carrying amount of group share in joint ventures

€ thousands	KSB Pumps Arabia Ltd.		Shanghai Electric-KSB Nuclear Pumps and Valves Co., Ltd.	
	2017	2016	2017	2016
Net carrying amount at 1 January	18,938	20,361	29,780	38,262
Earnings after income taxes	1,192	1,965	977	-7,098
Distribution of dividends	-1,902	-3,937	-	-
Other comprehensive income	-2,941	549	-1,870	-1,384
Net carrying amount at 31 December	15,287	18,938	28,887	29,780
Investment in joint venture (50% / 45%)	7,643	9,469	12,999	13,401
Elimination of intercompany profit and loss	-	-	-2,969	-3,058
Goodwill	-	-	-	-
Carrying amount at 31 December	7,643	9,469	10,030	10,343

Summarised information on joint ventures that are immaterial individually

€ thousands	Joint ventures 2017	Associates 2017	Total 2017	Joint ventures 2016	Associates 2016	Total 2016
Group share of earnings from continuing operations	211	583	794	266	524	790
Group share of other comprehensive income	-460	-	-460	107	-	107
Group share of comprehensive income	-249	583	334	383	524	907
Total carrying amounts of Group shares in these companies	3,347	1,165	4,512	3,595	1,032	4,627

As in the previous year, there are no pro rata losses that have not been recognised from the consolidation at equity.

5 Inventories

€ thousands	31 Dec. 2017	31 Dec. 2016
Raw materials, consumables and supplies	162,577	168,455
Work in progress	161,394	179,859
Finished goods and goods purchased and held for resale	121,421	100,534
Advance payments	16,485	18,589
	461,877	467,437

€ 51,933 thousand (previous year: € 52,336 thousand) of the inventories is carried at net realisable value. The impairment losses recognised as an expense in the reporting period amount to € 11,969 thousand (previous year: € 18,318 thousand). Due to new estimates, we reversed write-downs totalling € 1,303 thousand (previous year: € 7,856 thousand) where the current net realisable value was higher than the prior-period value. Inventories amounting to € 887,869 thousand (previous year: € 871,208 thousand) were recognised as an expense in the reporting period.

6 Trade receivables and PoC as well as other financial and non-financial assets

→ Trade receivables and PoC as well as other financial and non-financial assets

There were impairment losses on trade receivables from third parties of € 33,995 thousand (previous year: € 34,530 thousand) and on receivables from other investments of € 839 thousand (previous year: € 2,627 thousand). Impairment losses on receivables from loans to other equity investments amounted to € 3,127 (previous year: € 3,656). There were no impairment losses on receivables from joint ventures or associates, as in the previous year.

Sales revenue under IAS 11 amounts to € 376,499 thousand (previous year: € 406,604 thousand). The balance of receivables recognised by PoC (gross) carried as assets or liabilities includes costs of € 131,097 thousand (previous year: € 114,911 thousand) and a share in profits of € 37,695 thousand (previous year: € 32,167).

Other receivables and other current assets include hedges of credit balances prescribed by law for partial retirement arrangements and long-term working time accounts of the German Group companies in the amount of € 20,900 thousand (previous year: € 16,951 thousand).

Trade receivables and PoC as well as other financial and non-financial assets

€ thousands	31 Dec. 2017	31 Dec. 2016
Trade receivables and PoC	613,311	614,293
Trade receivables from third parties	480,928	504,595
Trade receivables from other investments, associates and joint ventures	32,341	33,576
thereof from other investments	3,524	6,480
thereof from associates	280	39
thereof from joint ventures	28,537	27,057
Receivables recognised by PoC, net	100,042	76,122
Receivables recognised by PoC, gross	130,021	107,144
Advances received from customers (PoC)	-29,979	-31,022
Other financial assets	116,970	186,995
Receivables from loans to other investments, associates and joint ventures	13,344	13,578
Currency forwards	5,074	2,170
Other receivables and other current assets	98,552	171,247
Other non-financial assets	37,402	24,923
Other tax assets	30,830	18,100
Deferred income	6,572	6,823

€ 23,681 thousand (previous year: € 25,230 thousand) of all receivables and other assets is due after more than one year.

7 Cash and cash equivalents

Cash and cash equivalents are term deposits with short maturities and call deposits, and also current account balances.

8 Equity

There was no change in the share capital of KSB as against the previous year. In accordance with the Articles of Association, it totals € 44,771,963.82 and, as in the previous year, is composed of 886,615 ordinary shares and 864,712 preference shares. Each no-par-value share represents an equal notional amount of the share capital. The preference shares carry separate cumulative preferred dividend rights and progressive additional dividend rights. All shares are no-par-value bearer shares. The individual shares have no par value.

The capital reserve results from the appropriation of premiums from capital increases in previous years.

In addition to revenue reserves from previous years, the revenue reserves include currency translation adjustments, consolidation effects, remeasurements of defined benefit plans under IAS 19 and changes in the market value of interest rate derivatives taken directly to equity. These effects resulted in deferred tax assets in the amount of € 70,477 thousand (previous year: € 75,663 thousand) and deferred tax liabilities in the amount of € 187 thousand (previous year: € 39 thousand).

A total of € 9,857 thousand (dividend of € 5.50 per ordinary share and € 5.76 per preference share) was paid from equity by resolution of the Annual General Meeting of the Group's parent company KSB SE & Co. KGaA, Frankenthal, on 10 May 2017.

Non-controlling interests relate primarily to PAB GmbH, Frankenthal, and the interests it holds, as well as to our companies in India and China. KSB SE & Co. KGaA holds a 51 % interest in PAB GmbH, while Johannes und Jacob Klein GmbH, Frankenthal, holds a 49 % interest.

Details of the changes in equity accounts and non-controlling interests are presented in the Statement of Changes in Equity.

The proposal on the appropriation of the net retained earnings of KSB SE & Co. KGaA calculated in accordance with *HGB* is shown at the end of these Notes.

Capital disclosures

Sufficient financial independence is a key requirement for safeguarding KSB's continued existence in the long term. Obtaining the necessary funds for ongoing business operations is also extremely important for us. A key management parameter for us is the net financial position, which is the balance of financial liabilities and interest-bearing financial assets (current and non-current financial instruments, interest-bearing loans, cash and cash equivalents, and receivables from cash deposits). Our long-term objective is to avoid net debt. We regularly monitor the development of this key performance indicator and manage it through active working capital management and by constantly optimising our financial structure, among other things. In the financial year we exceeded our original target of € 240 to 260 million and achieved € 288 million, based on further successes in working capital management and a consistently focused investment policy. Our net financial position was already developing more positively in the previous year than originally planned (€ 260 million compared with a planned figure of € 200 to 210 million). This can also be attributed to successes in working capital management and a focused investment policy.

9 Provisions

→ [Composition of provisions](#)

→ [Development of individual provision categories](#)

Provisions for pensions and similar obligations

The pension obligations in the KSB Group include defined contribution and defined benefit plans and contain both obligations from current pensions and future pension benefit entitlements.

For employees of Group companies in Germany there is a defined contribution plan under the German statutory pension insurance scheme into which the employer must pay the currently valid pension contribution rate. Contributions to state pension insurance funds recognised in the income statement totalled € 25,989 thousand (previous year: € 25,676 thousand). € 7,446 thousand (previous year: € 8,488 thousand) was spent on defined contribution schemes for employees in other countries in the year under review.

The obligations for defined benefit pension plans for employees of the Group are mainly due to pension obligations in Germany, as well as in France, the United States and Switzerland.

More than 90 % of the defined benefit pension plans are attributable to the German Group companies. These relate to direct commitments by the companies to their employees. The commitments are based on salary and length of service. Contributions from employees themselves are also considered. This pension provision can be broken down into purely company-financed basic provision and the top-up provision from the employer. The latter is based on the amount of own contributions and the generated return on sales before taxes on income. Both components take account of the general pension contribution (the amount of which partially depends on company performance), personal income (the relationship between pensionable income and maximum income threshold) and the annuity conversion factor (based on age). Pension benefits are paid in annual instalments of one tenth of the amount. However, under certain conditions it is also possible to make a capital payment or pay a monthly pension instead.

Pension schemes in France are governed by the provisions of the respective collective agreements. The obligations are basically covered by assets that have been paid in to an external fund. At the beginning of the final quarter of each year, an actuarial report is prepared to calculate the current obligation. If there is a shortfall, a compensation payment is made to the fund. Differences in the calculation parameters under local and

international law ultimately result in a surplus of obligations in the Group. Upon retirement, the employees concerned receive a one-off payment from the fund.

The defined benefit pension plans in the United States are closed to new entrants. The pension benefit amount is derived from the average salary and years of service before closure of the

Composition of provisions

€ thousands	31 Dec. 2017			31 Dec. 2016		
	Total	Non-current	Current	Total	Non-current	Current
Employee benefits	688,347	606,875	81,472	676,456	605,540	70,916
Pensions and similar obligations	586,861	586,861	–	589,542	589,542	–
Other employee benefits	101,486	20,014	81,472	86,914	15,998	70,916
Other provisions	99,804	1,397	98,407	99,566	1,406	98,160
Warranty obligations and contractual penalties	51,275	–	51,275	50,257	–	50,257
Provisions for restructuring	2,750	–	2,750	5,294	–	5,294
Miscellaneous other provisions	45,779	1,397	44,382	44,015	1,406	42,609
	788,151	608,272	179,879	776,022	606,946	169,076

Development of individual provision categories

€ thousands	1 Jan. 2017	Changes in consolidated Group/CTA* /		Reversal	Additions	31 Dec. 2017
		Other	Utilisation/Prepayments			
Employee benefits	676,456	–613	–71,179	–3,532	87,215	688,347
Pensions and similar obligations	589,542	–1,145	–18,055	–195	16,714	586,861
Other employee benefits	86,914	532	–53,124	–3,337	70,501	101,486
Other provisions	99,566	–510	–46,918	–11,512	59,178	99,804
Warranty obligations and contractual penalties	50,257	–1,205	–22,263	–6,001	30,487	51,275
Provisions for restructuring	5,294	–3	–3,827	–30	1,316	2,750
Miscellaneous other provisions	44,015	698	–20,828	–5,481	27,375	45,779
	776,022	–1,123	–118,097	–15,044	146,393	788,151

* CTA = Currency translation adjustments

plan. The retirement age is 65 years; from this point a monthly payment is made to the beneficiaries. The pension benefits are financed by external funds.

Pension obligations in Switzerland are predominantly based on statutory obligations. This also includes details on a minimum pension which all employees with uninterrupted contributions are entitled to by law. The employer is therefore required to pay in contributions which are high enough for the respective pension fund or insurance company to pay out these minimum amounts. As well as pension benefits, the plans encompass other benefits such as disability or survivors' benefits. Both employer and employee contributions are paid to the pension fund, with the company having to make contributions that at least match the employee contributions specified in the terms and conditions of the plan. The retirement benefits are paid out in monthly instalments, but all employees have the option to receive a (partial) capital payment.

In addition, employees in other countries are also entitled to a limited extent to retirement and partly to medical care benefits, depending mainly on the length of service and salary.

These defined benefit plans impose actuarial risks on the Group, such as the longevity risk and interest rate risk. The payments linked to pension obligations are paid largely from our liquid assets. Plan assets are also partially available for financing these obligations. Most of the plan assets are managed by insurers who set their own appropriate investment policies.

The actuarial valuations of the plan assets and the present value of the defined benefit obligation (and the related current service cost and the past service cost) are measured and calculated annually on the basis of actuarial reports using the projected unit credit method (IAS 19).

→ [Balance sheet figures for defined benefit plans](#)

→ [Change in cash value of defined benefit obligations](#)

The current and past service cost is recognised in staff costs under pension costs, and the interest cost is recognised in financial income/expense under interest and similar expenses.

The expected contributions in the following year are anticipated to be € 11,448 thousand (previous year: € 11,770 thousand).

→ [Changes in the fair value of the plan assets](#)

Interest income is recognised in financial income net of the DBO interest expense under interest and similar expenses.

→ [Changes to the net liability of the defined benefit obligations](#)

→ [Composition of plan assets](#)

We allocate to the pension funds the amount of money needed to meet statutory minimum requirements.

The actual income from plan assets amounted to € 5,109 thousand (previous year: € 4,843 thousand).

→ [Actuarial assumptions](#)

A mean fluctuation rate (2.0 %) continues to be applied to staff turnover for the German plans, as in the previous year. The biometric assumptions continue to be based on the 2005G mortality tables published by Prof. Klaus Heubeck as in the previous year, and the retirement age used for the calculations is based on the *Rentenversicherungs-Altersgrenzenanpassungsgesetz 2007 [RVAGAnpG – German Act Adapting the Standard Retirement Age for the Statutory Pension Insurance System]*. Other measurement parameters (e.g. cost trends in the medical care area) are not material.

The discount rate and future mortality were identified as key actuarial assumptions. As in the previous year the basis for the calculation of the sensitivities is the same method which was used for the calculation of the provisions for pensions and similar obligations.

Balance sheet figures for defined benefit plans

€ thousands	Defined benefit obligations (DBOs) 31 Dec. 2017	Fair value of plan assets 31 Dec. 2017	Net liability from defined benefit plans 31 Dec. 2017	Defined benefit obligations (DBOs) 31 Dec. 2016	Fair value of plan assets 31 Dec. 2016	Net liability from defined benefit plans 31 Dec. 2016
Germany	560,234	–	560,234	560,775	–	560,775
France	17,920	7,181	10,739	17,035	7,265	9,770
USA	14,217	12,066	2,151	15,936	12,180	3,756
Switzerland	17,253	15,769	1,484	17,998	16,493	1,505
Other countries	40,841	28,588	12,253	42,648	28,912	13,736
Balance sheet values	650,465	63,604	586,861	654,392	64,850	589,542

Change in cash value of defined benefit obligations

€ thousands	2017	2016
Opening balance of the defined benefit obligation (DBO) – 1 Jan.	654,392	589,377
Current service cost	9,858	15,867
Interest cost	12,844	14,269
Employee contributions	4,409	5,520
Remeasurements		
– / + Gain / loss from the change in demographic assumptions	1,206	–215
– / + Gain / loss from the change in financial assumptions	–5,340	52,479
– / + Experience-based gain / loss	–2,091	–2,481
Benefit payments	–18,614	–19,054
Past service cost (incl. effects of settlements and curtailments)	–218	445
Transfer of assets	–138	–559
Currency translation adjustments	–5,613	–1,141
Changes in consolidated Group / Other	–230	–115
Closing balance of the defined benefit obligation (DBO) – 31 Dec.	650,465	654,392

Changes in the fair value of the plan assets

€ thousands	2017	2016
Opening balance of the plan assets measured at fair value – 1 Jan.	64,850	63,344
Interest income	2,008	2,329
Remeasurements		
– / + Gain / loss from plan assets excluding amounts already recognised in interest income	3,101	2,514
Contributions by the employer	1,655	2,216
Contributions by the beneficiary employees	223	279
Currency translation adjustments	–4,485	–1,292
Changes in consolidated Group	–	–
Paid benefits	–2,801	–4,614
Other	–947	74
Closing balance of the plan assets measured at fair value – 31 Dec.	63,604	64,850

Changes to the net liability of the defined benefit obligations

€ thousands	2017	2016
Opening balance of the net liability of the defined benefit obligations – 1 Jan.	589,542	526,033
Current service cost	9,858	15,867
Interest income	–2,008	–2,329
Interest cost	12,844	14,269
Employee contributions	4,186	5,241
Contributions by the employer	–1,655	–2,216
Remeasurements		
– / + Gain / loss from plan assets excluding amounts already recognised in interest income	–3,101	–2,514
– / + Gain / loss from the change in demographic assumptions	1,206	–215
– / + Gain / loss from the change in financial assumptions	–5,340	52,479
– / + Experience-based gain / loss	–2,091	–2,481
Benefit payments	–15,813	–14,440
Past service cost (incl. effects of settlements and curtailments)	–218	445
Transfer of assets	–138	–559
Currency translation adjustments	–1,128	151
Changes in consolidated Group / Other	717	–189
Closing balance of the net liability of the defined benefit obligations – 31 Dec.	586,861	589,542

Composition of plan assets

€ thousands	Quoted market price in an active market	No quoted market price in an active market	Total	Quoted market price in an active market	No quoted market price in an active market	Total
	31 Dec. 2017	31 Dec. 2017	31 Dec. 2017	31 Dec. 2016	31 Dec. 2016	31 Dec. 2016
Equity instruments (shares)	19,660	–	19,660	20,538	–	20,538
Debt instruments (loans)	16,782	–	16,782	22,469	–	22,469
Government bonds	8,817	–	8,817	8,602	–	8,602
Corporate bonds	7,965	–	7,965	13,867	–	13,867
Currency forwards	–	–	–	20	–	20
Money market investments	7,611	–	7,611	373	–	373
Real estate	520	–	520	880	–	880
Insurance contracts	–	16,319	16,319	–	17,295	17,295
Bank credit balances	1,482	–	1,482	2,115	–	2,115
Other investments	870	360	1,230	800	360	1,160
Total	46,925	16,679	63,604	47,195	17,655	64,850

Actuarial assumptions

in %	Discount rate		Assumed rate of salary increase		Assumed rate of pension increase	
	31 Dec. 2017	31 Dec. 2016	31 Dec. 2017	31 Dec. 2016	31 Dec. 2017	31 Dec. 2016
Germany	1.9	1.9	2.7	2.7	1.9	1.9
France	1.35	2.0	3.0	3.0	–	–
USA	3.4	3.8	–	2.3	–	2.3
Switzerland	0.6	0.6	1.0	1.0	–	1.0
Other countries	0.75–10.4	0.75–9.9	1.0–11.0	1.0–10.5	1.5–3.0	1.5–3.1

Were the discount factor to increase by 100 basis points, the DBO would fall by € 102 million (previous year: € 107 million). A 100 basis point reduction in the discount factor would increase the DBO by € 131 million (previous year: € 145 million). It should be noted that a change in the discount factor due to particular financial effects (such as compound interest) does not affect the development of the DBO on a straight-line basis. Were life expectancy to increase by 1 year, the DBO would increase by € 20 million (previous year: € 27 million).

Additionally, the individual actuarial assumptions are mutually dependent, but these interdependencies are not taken into account in the sensitivity analysis.

On 31 December 2017 the weighted average term of the DBO was 24 years (previous year: 23 years).

→ **Expected pension benefit payments**

Expected pension benefit payments

€ millions at 31 Dec. 2017	2018	2019	2020	2021	2022
Expected payments	23,964	21,181	21,241	22,230	21,716

€ millions at 31 Dec. 2016	2017	2018	2019	2020	2021
Expected payments	21,659	21,315	21,549	21,605	22,569

Other employee benefits

Provisions for other employee benefits relate primarily to profit-sharing, jubilee payments, partial retirement obligations and severance payments. The provisions include € 15,770 thousand (previous year: € 12,234 thousand) created on account of the Efficiency Improvement Programme.

Other provisions

The provisions for warranty obligations and contractual penalties cover the statutory and contractual obligations to customers and are based on estimates prepared using historical data for similar products and services.

The miscellaneous other provisions include provisions for anticipated losses from the project business (€ 4,656 thousand for 2017 and € 1,667 thousand for 2016), customer bonuses and environmental protection measures. They also cover risks of litigation and legal proceedings if the recognition criteria for a pro-

vision are met (€ 5.3 million; previous year: € 9.2 million). These are usually risks arising from legal disputes in relation to operations or, in rare cases, disputes with government agencies or personnel matters. In order to determine the amount of the provisions, the facts related to each case, the size of the claim, the results of comparable proceedings and independent legal opinions are considered in individual cases along with assumptions regarding the probability of occurrence and the range of potential claims. In addition, there are contingent liabilities resulting from legal disputes in relation to the operative business in the amount of € 56.7 million (previous year: € 71.8 million). There are no longer any insurance claims to be covered for 2017 (previous year: € 11.0 million).

€ 18,489 thousand (previous year: € 18,392 thousand) of the other provisions are expected to become cash-effective after more than one year.

10 Liabilities**Non-current liabilities**

€ thousands	31 Dec. 2017	31 Dec. 2016
Financial liabilities	54,333	57,962
Loan against borrower's note	47,964	47,918
Bank loans and overdrafts	5,468	9,229
Finance lease liabilities	574	693
Other	327	122

Current liabilities

€ thousands	31 Dec. 2017	31 Dec. 2016
Financial liabilities	21,960	119,958
Loan against borrower's note	–	74,500
Bank loans and overdrafts	21,275	44,571
Finance lease liabilities	353	501
Liabilities to other investments, associates and joint ventures	322	376
Other	10	10
Trade payables	212,029	210,813
Trade payables to third parties	210,819	208,774
Liabilities to other investments, associates and joint ventures	1,210	2,039
Other financial liabilities	81,467	89,406
Advances received from customers PoC (net)	49,401	44,046
Advances received from customers PoC (gross)	88,172	83,980
Receivables recognised by PoC	–38,771	–39,934
Currency forwards	1,883	11,203
Interest rate swaps	–	435
Miscellaneous other financial liabilities	30,183	33,722
Other non-financial liabilities	190,161	182,979
Advances received from customers	97,703	92,505
Social security and liabilities to employees	48,703	52,657
Tax liabilities (excluding income taxes)	28,171	22,022
Prepaid expenses	10,788	10,882
Investment grants and subsidies	4,796	4,913
Income tax liabilities	5,214	9,354

In 2012, to safeguard liquidity in the medium term, KSB SE & Co. KGaA took the precaution of placing a loan against borrower's note with a total volume of € 175 million. This loan is divided into repayment tranches of 3, 5, 7 and 10 years. As the different repayment tranches have different terms, different rates of interest apply, some of which are fixed and some variable. In the year under review, € 74.5 million was repaid; in the previous year there were no repayments.

Further information on receivables recognised by PoC can be found in Section IV. Balance Sheet Disclosures – Notes No. 6. "Trade receivables and PoC as well as other financial and non-financial assets".

€ 27.5 million (unchanged on the previous year) of the liabilities arising from the loan against borrower's note are classified as bank loans and overdrafts, and € 20.5 million as other financial liabilities (also unchanged).

Assets amounting to € 6,098 thousand (previous year: € 2,351 thousand) have been pledged as security in the KSB Group for bank loans and other liabilities on the basis of standard terms

and conditions. Of these, none (as in the previous year) relate to property, plant and equipment, € 1,522 thousand (previous year: € 724 thousand) to inventories, none (as in the previous year) to receivables and € 4,576 thousand (previous year: € 1,627 thousand) to other securities.

As in the previous year, no liabilities were secured by land charges or similar rights in the year under review.

The reported investment grants and subsidies largely comprise funding from the European Union and German entities for new buildings and development aid projects.

The weighted average interest rate on bank loans and overdrafts as well as on an open-market credit (loan against borrower's note) was 4.31 % (previous year: 3.44 %). Interest rate risk exists for the major portion of the loan against borrower's note mentioned above.

There were no covenant agreements for loans in the year under review, as was the case in the previous year too.

V. INCOME STATEMENT DISCLOSURES

11 Sales revenue

€ thousands	2017	2016
Revenue from the sale of goods and goods purchased and held for resale	1,951,928	1,915,739
Services sales revenue	253,030	249,913
Sales revenue	2,204,958	2,165,652

The breakdown of sales revenue by pumps, valves and service is presented in the segment reporting.

12 Other income

€ thousands	2017	2016
Income from disposal of assets	12,319	1,478
Income from current assets	5,834	9,277
Currency translation gains	5,767	3,629
Income from the reversal of provisions	14,845	8,400
Miscellaneous other income	30,405	24,443
	69,170	47,227

Income from current assets is primarily from the reversal of impairment losses on receivables. Miscellaneous other income relates primarily to insurance compensation amounting to € 12,491 thousands (previous year: € 1,899 thousands). Grants and subsidies, rental and lease income and commission income are also part of miscellaneous other income. Income from gov-

ernment grants for individual projects (for example, for research activities) amounted to € 3,065 thousand (previous year: € 2,564 thousand).

13 Cost of materials

€ thousands	2017	2016
Cost of raw materials, production supplies and of goods purchased and held for resale	795,559	789,298
Cost of purchased services	92,261	84,858
	887,820	874,156

14 Staff costs

€ thousands	2017	2016
Wages and salaries	640,390	641,451
Social security contributions and employee assistance costs	128,563	129,574
Pension costs	27,779	27,725
	796,732	798,750

Pension costs are reduced by the interest component of provisions for pensions and similar obligations, which is reported as an interest cost in financial income/expense.

→ Employees

The first-time inclusion of fully consolidated companies in China and in the Philippines led to an increase of 43 in the average number of employees over the year and in the total number at the reporting date.

Employees

	Average for the year		At reporting date	
	2017	2016	31 Dec. 2017	31 Dec. 2016
Wage earners	6,998	7,311	6,954	7,091
Salaried employees	8,073	8,125	8,047	8,015
	15,071	15,436	15,001	15,106
Apprentices	450	477	454	466
	15,521	15,913	15,455	15,572

15 Other expenses

€ thousands	2017	2016
Losses from asset disposals	3,169	1,270
Losses from current assets (primarily impairment losses on receivables)	10,867	12,744
Currency translation losses	5,508	2,222
Other staff costs	38,480	31,157
Repairs, maintenance, third-party services	96,981	85,816
Selling expenses	66,083	73,835
Administrative expenses	84,232	83,657
Rents and leases	27,232	26,898
Miscellaneous other expenses	59,862	54,842
	392,414	372,441

Miscellaneous other expenses relate primarily to warranties and contractual penalties amounting to € 13.5 million (previous year: € 14.0 million), as well as additions to provisions. Other staff costs include expenses within the scope of the Efficiency Improvement Programme of € 10.3 million (previous year: € 12.2 million)

16 Financial income / expense

→ Financial income / expense

Interest and similar expenses include the interest cost on pension provisions amounting to € 10,836 thousand (previous year: € 11,940 thousand). The change in the financial results is mainly due to the positive result from investments accounted for using the equity method.

17 Taxes on income

All income-related taxes of the consolidated companies and deferred taxes are reported in this item. Other taxes are reported in the income statement after other expenses.

Taxes on income

€ thousands	2017	2016
Effective taxes	36,053	41,160
Deferred taxes	16,023	-14,296
	52,076	26,864

Financial income / expense

€ thousands	2017	2016
Financial income	6,417	6,612
Income from equity investments	253	147
thereof from other investments	(253)	(147)
Interest and similar income	6,139	6,357
thereof from other investments	(36)	(37)
thereof from investments accounted for using the equity method	(644)	(20)
Other financial income	25	108
Financial expense	-20,106	-20,672
Interest and similar expenses	-19,204	-19,885
thereof to other investments	(0)	(1)
Write-downs on other investments	-853	-
Write-downs on investments accounted for using the equity method	-	-
Expenses from the remeasurement of financial instruments	-	-62
Other financial expense	-49	-725
Income / expense from / to investments accounted for using the equity method	1,514	-1,342
Financial income / expense	-12,175	-15,402

€ 425 thousand (previous year: € 875 thousand) of the effective taxes in the year under review related to prior-period tax refunds and € 2,632 thousand (previous year: € 2,923 thousand) to tax arrears.

Reconciliation of deferred taxes

€ thousands	2017	2016
Change in deferred tax assets	20,430	-27,806
Change in deferred tax liabilities	2,328	-664
Change in deferred taxes recognised in balance sheet	22,758	-28,470
Change in deferred taxes taken directly to equity	-6,100	13,999
Changes in consolidated Group/CTA* /Other	-635	175
Deferred taxes recognised in income statement	16,023	-14,296

* CTA = Currency translation adjustments

→ Allocation of deferred taxes

Allocation of deferred taxes

€ thousands	Deferred tax assets		Deferred tax liabilities	
	2017	2016	2017	2016
Non-current assets	1,456	1,828	28,220	31,309
Intangible assets	739	1,152	105	279
Property, plant and equipment	717	612	28,060	30,964
Non-current financial assets	-	64	55	66
Current assets	54,912	57,152	50,142	45,621
Inventories	49,356	48,516	143	1,924
Receivables and other current assets	5,556	7,096	49,999	43,554
Assets held for sale	-	1,540	-	143
Non-current liabilities	93,504	96,462	88	25
Provisions	93,312	96,305	77	-
Other liabilities	192	157	11	25
Current liabilities	15,806	20,949	11,438	8,573
Provisions	10,408	11,248	1,261	1,201
Other liabilities	5,398	9,701	10,177	7,372
Tax loss carryforwards	1,243	8,928	-	-
Gross deferred taxes – before offsetting	166,921	185,319	89,888	85,528
Offset under IAS 12.74	-75,185	-73,153	-75,185	-73,153
Net deferred taxes – after offsetting	91,736	112,166	14,703	12,375

As at the reporting date, deferred tax assets of € 80,111 thousand (previous year: € 97,825 thousand) were recognised, arising from companies posting a loss in the financial year or previous year, whose realisation exclusively depends on the creation of future profit. Based on the planning figures available, we expect realisation to take place.

Income taxes included under equity

€ thousands	2017	2016
Remeasurement of defined benefit plans	9,328	-47,278
Taxes on income	-3,843	13,546
Currency translation differences	-54,238	20,223
Taxes on income	-	-
Changes in the fair value of financial instruments	7,203	-1,622
Taxes on income	-2,257	453
Other comprehensive income	-43,807	-14,678

The introduction of new local taxes had minor effects (previous year: none) in the year under review. Changes in foreign tax rates led to a reduction in the total tax expense of € 2,386 thousand (previous year: reduction of € 664 thousand).

As far as net income from affiliates and other equity investments is concerned, withholding taxes incurred in connection with distributions and German taxes incurred are recognised as deferred taxes if these gains are expected to be subject to corresponding taxation, or there is no intention of reinvesting them in the long term. No deferred tax liabilities were recognised for temporary differences of € 108,394 thousand (previous year: € 130,581 thousand) in relation to affiliates and associates as it is unlikely that these temporary differences will be reversed in the foreseeable future.

We did not recognise deferred tax assets for loss carryforwards amounting to € 78,748 thousand (previous year: € 41,720 thousand) because it is unlikely that there will be sufficient taxable profit available in the near future against which these deferred tax assets can be utilised. They are largely available for an indefinite period.

Deductible temporary differences for which no deferred tax assets had to be set up amounted to € 32,722 thousand (previous year: € 9,145 thousand).

→ Reconciliation of income taxes

The unchanged applicable tax rate of 30 % is a composite rate resulting from the current German corporation tax, solidarity surcharge and trade tax rates.

Reconciliation of income taxes

€ thousands	2017	2016
Earnings before income taxes (EBT)	104,180	74,641
Calculated income taxes on the basis of the applicable tax rate (30 % as in the previous year)	31,254	22,392
Differences in tax rates	-3,297	-793
Unused tax loss carryforwards	4,229	-108
Impairment losses on deferred taxes on tax loss carryforwards	7,012	-
Impairment loss on goodwill	1,222	1,542
Impairment losses on deferred taxes for temporary differences	3,991	-
Tax-exempt income	-2,381	-1,184
Non-deductible expenses	7,548	1,231
Prior-period taxes	2,207	2,048
Non-deductible foreign income tax	2,406	3,396
Investments accounted for using the equity method	-408	662
Deferred taxes not recognised	-	-273
Other	-1,707	-2,049
Current taxes on income	52,076	26,864
Current tax rate	50 %	36 %

18 Earnings after income taxes – Non-controlling interests

The net profit attributable to non-controlling interests amounts to € 15,770 thousand (previous year: € 15,190 thousand) and the net loss attributable to non-controlling interests amounts to € 847 thousand (previous year: € 356 thousand). They relate primarily to PAB GmbH, Frankenthal, Germany, and the interests it holds, as well as to our companies in India and Pakistan.

19 Earnings per share

Earnings per share

		2017	2016
Earnings after income taxes attributable to KSB SE & Co. KGaA shareholders	€ thousands	37,181	32,943
Additional dividend attributable to preference shareholders (€ 0.26 per preference share)	€ thousands	-225	-225
	€ thousands	36,956	32,718
Number of ordinary shares		886,615	886,615
Number of preference shares		864,712	864,712
Total number of shares		1,751,327	1,751,327
Diluted and basic earnings per ordinary share	€	21.10	18.68
Diluted and basic earnings per preference share	€	21.36	18.94

VI. ADDITIONAL DISCLOSURES ON FINANCIAL INSTRUMENTS

Financial instruments – Carrying amounts and fair values by measurement category:

Financial instruments by measurement categories – Assets

Balance sheet item / Class € thousands	Measure- ment category	Initial / subsequent measurement	Carrying amount 31 Dec. 2017	Fair value 31 Dec. 2017	Carrying amount 31 Dec. 2016	Fair value 31 Dec. 2016
Non-current assets						
Other investments	n / a	Amortised cost	2,985	–	5,401	–
Non-current financial instruments	AfS	Fair value	657	657	667	667
Loans	LaR	Fair value / Amortised cost	2,490	2,490	2,458	2,458
Current assets						
Trade receivables	LaR	Fair value / Amortised cost	480,928	480,928	504,595	504,595
Trade receivables from other investments, associates and joint ventures	LaR	Fair value / Amortised cost	32,341	32,341	33,576	33,576
Receivables from loans to other invest- ments, associates and joint ventures	LaR	Fair value / Amortised cost	13,344	13,344	13,578	13,578
Receivables recognised by PoC, net	LaR	Fair value / Amortised cost	100,042	100,042	76,122	76,122
Currency forwards used as hedges	n / a	Fair value	5,074	5,074	2,170	2,170
Other receivables and other current assets	LaR	Fair value / Amortised cost	98,552	98,552	171,247	171,247
Cash and cash equivalents	LaR	Fair value / Amortised cost	289,535	289,535	288,883	288,883

Financial instruments by measurement categories – Equity and liabilities

Balance sheet item / Class € thousands	Measure- ment category	Initial / subsequent measurement	Carrying amount 31 Dec. 2017	Fair value 31 Dec. 2017	Carrying amount 31 Dec. 2016	Fair value 31 Dec. 2016
Non-current liabilities						
Financial liabilities excluding finance lease liabilities	FLAC	Fair value / Amortised cost	53,759	52,622	57,269	55,803
Finance lease liabilities	n / a	Under IAS 17	574	579	693	699
Current liabilities						
Financial liabilities excluding finance lease liabilities	FLAC	Fair value / Amortised cost	21,607	21,607	119,457	119,457
Finance lease liabilities	n / a	Under IAS 17	353	359	501	561
Trade payables	FLAC	Fair value / Amortised cost	212,029	212,029	210,813	210,813
Advances received from customers (PoC)	FLAC	Fair value / Amortised cost	49,401	49,401	44,046	44,046
Interest rate swaps used as hedges	n / a	Fair value	–	–	435	435
Currency forwards used as hedges	n / a	Fair value	1,883	1,883	11,203	11,203
Other financial liabilities	FLAC	Fair value / Amortised cost	30,183	30,183	33,722	33,722
Thereof aggregated by category in accordance with IAS 39						
Loans and receivables	LaR	Fair value / Amortised cost	1,017,232	1,017,232	1,090,459	1,090,459
Available-for-sale financial instruments	AfS	Fair value	657	657	667	667
Financial liabilities measured at amortised cost	FLAC	Fair value / Amortised cost	366,979	365,842	465,307	463,841

The carrying amount of financial assets measured at amortised cost, with the exception of non-current loans, approximates fair value. This is also the case for all financial liabilities shown on the balance sheet, with the exception of non-current financial liabilities. This is mainly due to the short maturities of these financial instruments.

The fair values of non-current financial liabilities and loans are determined as the present value of the cash flows associated with the liabilities. We apply an appropriate yield curve to arrive at this present value.

The fair values of the current and non-current financial instruments presented in the table above are based on prices quoted in active markets (level 1). Fair values within level 2 are determined based on a discounted cash flow method. Future cash flows from currency forwards are estimated on the basis of forward exchange rates (observable rates on the reporting date) and the contracted forward exchange rates, and are discounted

with an adequate interest rate. Future cash flows from interest rate swaps are estimated on the basis of forward interest rates (observable interest structure curves on the reporting date) and the contracted interest rates, and are discounted with an adequate interest rate. Level 3 includes financial instruments whose fair value is determined on the basis of inputs not based on observable market data. Foreign exchange derivatives are measured using forward exchange rates. For interest rate swaps the fair value is determined through the discount rate of future expected cash flows based on the market interest rates and yield curves that apply to the remaining term of the contracts.

The following table shows the financial assets and liabilities, as well as loans and receivables, measured at fair value on a recurring basis, broken down into measurement categories and the previously described hierarchy levels. There were no reclassifications carried out during the year under review.

→ [Hierarchy levels 2017](#)

→ [Hierarchy levels 2016](#)

Hierarchy levels 2017

€ thousands	Level 1	Level 2	Level 3	Total
Financial assets recognised at fair value				
Current financial instruments	657	–	–	657
Currency forwards	–	5,074	–	5,074
Financial liabilities recognised at fair value				
Currency forwards	–	1,883	–	1,883
Interest rate swaps	–	–	–	–
Loans and receivables measured at amortised cost				
Loans	–	2,490	–	2,490
Trade receivables	–	480,928	–	480,928
Receivables from other investments, associates and joint ventures	–	45,685	–	45,685
Receivables recognised by PoC (inc. advances received from customers PoC)	–	100,042	–	100,042
Other receivables and other current assets	–	98,552	–	98,552
Cash and cash equivalents	–	289,535	–	289,535
Financial liabilities measured at amortised cost				
Financial liabilities excluding finance lease liabilities	–	74,229	–	74,229
Trade payables	–	212,029	–	212,029
Advances received from customers (PoC)	–	49,401	–	49,401
Miscellaneous other financial liabilities	–	30,183	–	30,183

The net gains and losses from financial instruments, after taking into account the relevant tax effect, are presented in the following table:

→ [Net results by measurement category in 2017](#)

→ [Net results by measurement category in 2016](#)

The interest shown is a component of financial income/expense. The effect from the application of the effective interest rate method is immaterial here as the interest expenses are virtually offset by the resulting interest income. The other gains and losses are partly reported in other income and other expenses.

The AfS measurement category resulted in a remeasurement value of € 0 thousand (previous year: € –4 thousand), which was recognised directly in other comprehensive income and reported under “Change in the fair value of financial instruments” in equity. In the year under review, € 0 thousand (previous year: € 0 thousand) was withdrawn from equity or realised.

The amount of financial assets and liabilities subject to offsetting agreements is not material.

Financial risks

We are exposed to certain financial risks as a consequence of our business activities. These risks can be classified into three areas:

For one thing, we are exposed to credit risk. We define credit risk as potential default or delays in the receipt of contractually agreed payments. We are also exposed to liquidity risk, which is the risk that an entity will be unable to meet its financial obligations, or will be unable to meet them in full. Finally, we are exposed to market risk. The risk of exchange rate or interest rate changes may adversely affect the economic position of the Group. Risks from fluctuations in the prices of financial instruments are not material for us.

Hierarchy levels 2016

€ thousands	Level 1	Level 2	Level 3	Total
Financial assets recognised at fair value				
Current financial instruments	667	–	–	667
Currency forwards	–	2,170	–	2,170
Financial liabilities recognised at fair value				
Currency forwards	–	11,203	–	11,203
Interest rate swaps	–	435	–	435
Loans and receivables measured at amortised cost				
Loans	–	2,458	–	2,458
Trade receivables	–	504,595	–	504,595
Receivables from other investments, associates and joint ventures	–	47,154	–	47,154
Receivables recognised by PoC (inc. advances received from customers PoC)	–	76,122	–	76,122
Other receivables and other current assets	–	171,247	–	171,247
Cash and cash equivalents	–	288,883	–	288,883
Financial liabilities measured at amortised cost				
Financial liabilities excluding finance lease liabilities	–	175,260	–	175,260
Trade payables	–	210,813	–	210,813
Advances received from customers (PoC)	–	44,046	–	44,046
Miscellaneous other financial liabilities	–	33,722	–	33,722

Net results by measurement category in 2017

€ thousands	From interest and dividends	From subsequent measurement			From disposal	Net results
		At fair value	Currency translation	Impairment losses		
LaR	6,164	–	–718	–1,476	–	3,970
AfS	265	–	–	–2	–	263
FLAC	–9,542	–	228	–	–	–9,314
	–3,113	–	–490	–1,478	–	–5,081

Net results by measurement category in 2016

€ thousands	From interest and dividends	From subsequent measurement			From disposal	Net results
		At fair value	Currency translation	Impairment losses		
LaR	6,357	–	–1,029	–6,815	–	–1,487
AfS	161	–	–	–	–87	74
FLAC	–7,607	–	2,636	–	–	–4,971
	–1,089	–	1,607	–6,815	–87	–6,384

We limit all of these risks through an appropriate risk management system, and define how these risks are addressed through guidelines and work instructions. In addition, we monitor the current risk characteristics continuously and regularly provide the information obtained in this way to the Managing Directors and the Supervisory Board in the form of standardised reports and individual analyses.

The three risk areas are described in detail in the following. Additional information is also provided in the group management report, in particular in the Economic Review, Report on Expected Developments, Opportunities and Risks Report sections.

Credit risk

The primary credit risk is that there is a delay in settling a receivable, or that it is not settled either in full or in part. We minimise this risk using a variety of measures. As a matter of principle, we run credit checks on potential and existing counterparties. We only enter into business relationships if the results of this check are positive. Additionally, our European companies in particular

take out trade credit insurance policies. As in the previous year, these policies account for around 10 % of the Group's trade receivables in total. In exceptional cases we accept other securities (collateral) such as guarantees. The insurance policies primarily cover the risk of loss of receivables. Moreover, we also take out cover against political and commercial risks in the case of certain customers in selected countries. For both types of insurance, we have agreed deductibles, which represent significantly less than 50 % of the insured volume. As part of our receivables management system, we continuously monitor outstanding items, perform maturity analyses and establish contact with customers at an early stage if delays in payment occur. In the case of major projects, our terms and conditions provide for prepayments, guarantees and – for export transactions – letters of credit. These also mitigate risk. Impairment losses are recognised for the residual risk remaining in trade receivables. We examine regularly the extent to which individual receivables need to be written down for impairment. Indications of this are significant financial difficulties of the debtor, such as insolvency or bankruptcy. We also cover the credit risk of receivables that are past due by providing for the risk involved on the basis of historical loss

experience. Receivables are derecognised if it is reasonably certain that receipt of payment cannot be expected (for example, after completion of insolvency or bankruptcy proceedings).

Impairment losses on trade receivables are the only material impairment losses in the KSB Group.

Impairment losses from the "trade receivables" category

€ thousands	2017	2016
Opening balance at 1 January	34,530	35,560
Additions	8,219	9,776
Utilised	-3,004	-4,614
Reversals	-3,903	-5,818
Changes in consolidated Group / CTA* / Other	-1,847	-374
Closing balance at 31 December	33,995	34,530

* CTA = Currency translation adjustments

Maturity structure for trade receivables

€ thousands	31 Dec. 2017	31 Dec. 2016
Receivables that are neither past due nor individually impaired	329,503	364,733
Receivables that are past due but not individually impaired		
1 to 30 days	62,517	49,802
31 to 90 days	31,251	29,827
91 to 180 days	16,839	16,590
>180 days	35,091	30,716
Total	145,698	126,935
Receivables individually determined to be impaired	5,727	12,927
Receivables individually determined to be impaired at their principal amount	39,722	47,457
Specific write-downs	33,995	34,530
Carrying amount (net)	480,928	504,995

With regard to the trade receivables that are neither past due nor individually impaired, there are no indications at the reporting date that our debtors will not meet their payment obligations. The same applies to all other financial instruments.

The maximum default risk, excluding collateral received, corresponds to the carrying amount of the financial assets.

There is no concentration of risk because the diversity of our business means that we supply a considerable number of customers in different sectors.

Liquidity risk

Our liquidity management ensures that we minimise this risk in the Group and that our solvency is ensured at all times. There are no concentrations of risk because we work together with a number of credit institutions, on which we impose strict creditworthiness requirements.

We generate our financial resources primarily from our operating business. We use them to finance investments in non-current assets. We also use them to cover our working capital requirements. To keep these as low as possible, we monitor changes in our receivables, inventories and liabilities regularly using a standardised Group reporting system.

The reporting system additionally ensures, with the help of monthly rolling cash flow planning, that the Group's centralised financial management is continuously informed about liquidity surpluses and requirements. This enables us to optimally meet the needs of the Group as a whole and of the individual companies. For selected companies we use a cash pooling system to ensure that available cash is deployed optimally within the Group. We also apply a worldwide receivables netting procedure within the KSB Group so as to minimise both the volume of cash flows and the associated fees. In order to be able to provide the necessary collateral in the project business, corresponding guarantee volumes are made available. Adequate proportions are confirmed for a period of more than one year. In addition, we always ensure that credit facilities are sufficient; we identify the need for these on the basis of regular liquidity plans. In this way we can react to fluctuating liquidity requirements at all times. Our approved cash loans and credit lines total approximately € 893.5 million (previous year: approx. € 968.7 million), of which € 620.2 million has not yet been utilised (previous year: € 648.1 million).

The following tables show the contractually agreed non-discounted future cash flows of the financial liabilities (primary financial instruments) and derivative financial instruments. Interest payments on fixed-rate liabilities are determined on the basis of the fixed rate. Floating-rate interest payments are based on the last floating interest rates fixed before 31 December. Projections for future new liabilities are not included in the presentation. Based on our current state of knowledge, it is neither expected that the cash flows will take place significantly earlier, nor that the amounts will differ significantly.

→ [Cash flows of financial liabilities 2017](#)

→ [Cash flows of financial liabilities 2016](#)

Market price risk

Our global business activities expose us primarily to currency and interest rate risk. Any changes in market prices can affect fair values and future cash flows. We use sensitivity analyses to determine the hypothetical impact of such market price fluctuations on profit and equity. In doing so, we assume that the portfolio at the reporting date is representative for the full year.

We reduce the risks resulting from changes in prices on the procurement side for orders with extended delivery dates by agreeing cost escalation clauses or, in the case of fixed-price contracts, by including the expected rate of cost increases in our sales price.

Currency risk mainly affects our cash flows from operating activities. It arises when Group companies settle transactions in currencies that are not their functional currency. We minimise this risk using currency forwards and, on rare occasions, options. You will find further information on this in the “Derivative financial instruments” section of the Notes. We use micro hedges with regard to both transactions already recognised and cash flows that are expected in the future with a high degree of probability. The hedging instruments used share the essential terms and conditions with the underlying transactions, i.e. with regard to amount, term and quality. Internal guidelines govern the use of financial instruments. Such transactions are also subject to ongoing risk control measures. The hedging instruments used are exclusively currency forwards entered into

Cash flows of financial liabilities 2017

€ thousands	Total	Up to 1 year	1–5 years	> 5 years
Financial liabilities	82,888	24,827	57,504	557
Trade payables	212,029	212,029	–	–
Miscellaneous other financial liabilities	30,184	30,176	8	–
Derivative financial instruments – Incoming payments	–5,074	–4,690	–384	–
Derivative financial instruments – Outgoing payments	1,883	1,489	375	19
	321,910	263,831	57,503	576

Cash flows of financial liabilities 2016

€ thousands	Total	Up to 1 year	1–5 years	> 5 years
Financial liabilities	190,914	127,826	39,477	23,611
Trade payables	210,813	210,813	–	–
Miscellaneous other financial liabilities	33,722	29,801	3,921	–
Derivative financial instruments – Incoming payments	–3,094	–2,718	–376	–
Derivative financial instruments – Outgoing payments	12,562	11,000	1,493	69
	444,917	376,722	44,515	23,680

with prime-rated banks. In order to measure the effectiveness of our hedges, the market values of the underlying and the hedge transactions are compared. Changes in the market values of the derivatives are almost completely offset by changes in the fair values of the cash flows from the underlyings (hypothetical derivative method). As a rule, we do not hedge currency risks from the translation of foreign operations into the Group currency (€).

At the reporting date, the notional volume of all currency forwards was € 276,489 thousand (previous year: € 269,794 thousand), and the notional volume of all interest rate derivatives was € 0 thousand (previous year: € 39,500 thousand). The contractual maturities of payments for currency forwards and interest rate derivatives are as follows:

→ [Notional volumes 2017](#)

→ [Notional volumes 2016](#)

Notional volumes 2017

€ thousands	Total	Up to 1 year	1–5 years	> 5 years
Currency forwards	276,489	261,560	14,819	110
Interest rate derivatives	–	–	–	–
	276,489	261,560	14,819	110

Notional volumes 2016

€ thousands	Total	Up to 1 year	1–5 years	> 5 years
Currency forwards	269,794	203,390	670	65,704
Interest rate derivatives	39,500	39,500	–	–
	309,294	242,890	670	65,704

Changes in derivatives

€ thousands	2017	2016
Opening balance at 1 January	–6,644	–5,026
Changes in consolidated Group / CTA* / Other	–272	8
Disposals	8,179	948
Additions	–686	–2,574
Closing balance at 31 December	577	–6,644

* CTA = Currency translation adjustments

The main currencies in the KSB Group are the Chinese yuan (CNY) and US dollar (USD). For the currency sensitivity analysis, we simulate the effects based on the notional volume of our existing foreign currency derivatives and our foreign currency receivables and liabilities at the reporting date. For the analysis, we assume a 10 % increase (decrease) in the value of the euro versus the other currencies. In the reporting year, this would have amounted to approximately € 1.5 million for CNY (previous year: € 2.0 million) and € 1.2 million (previous year: € 1.2 million) for USD.

→ [Currency volumes](#)

Currency volumes

	CNY 31 Dec. 2017	CNY 31 Dec. 2016	USD 31 Dec. 2017	USD 31 Dec. 2016
Trade receivables	€ 57.5 million	€ 66.7 million	€ 22.3 million	€ 26.4 million
Trade payables	€ 42.1 million	€ 46.6 million	€ 10.8 million	€ 14.9 million
Balance	€ 15.4 million	€ 20.1 million	€ 11.5 million	€ 11.5 million

Based on the measurement of derivatives, at the reporting date, equity and the fair value of the derivatives would have been € 11.7 million lower (higher), with € 9.0 million resulting from USD and € 2.7 million from the other currencies. At the previous year's reporting date, equity and the fair value of the derivatives would have been € 11.3 million lower (higher), with € 8.7 million resulting from USD and € 2.6 million from the other currencies.

We regularly monitor the interest rate risks associated with our financing activities. To avoid the negative effects of interest rate fluctuations on the international capital markets, we conclude interest rate hedges (interest rate swaps) where necessary, generally for long-term loans. These are used exclusively to hedge floating rate loans against rising interest rates. No such transactions were recognised in the financial year.

As part of our interest rate sensitivity analysis, we simulate a 50 basis point increase (decrease) in market interest rates and analyse the impact on the floating rate financial instruments. In 2017, the net interest balance would have been € 1.7 million (€ 1.2 million) (previous year: € 2.0 million (€ 2.0 million) higher (lower)). There were no interest rate derivatives in the Group in the financial year. In the previous year, changes in the fair value of interest rate derivatives used to hedge floating rate liabilities increased (decreased) equity by € 0.1 million (€ 0.1 million).

VII. STATEMENT OF CASH FLOWS

In the statement of cash flows, cash flows are classified by operating, investing and financing activities. Effects of changes in the consolidated Group and in exchange rates are eliminated in the

relevant items. The effect of exchange rate changes (based on annual average rates) and changes in the consolidated Group on cash and cash equivalents is presented separately.

Cash flows from operating activities include a "cash flow" subtotal that merely comprises the net profit for the year; depreciation, amortisation and impairment losses as well as reversals of impairment losses; changes in non-current provisions; and non-cash effects, for example, of the disposal of fixed assets. This subtotal is combined with the changes in the other operating components of assets (including current financial instruments) and liabilities to determine cash flows from operating activities. Only those changes that are recognised in the income statement are taken into account.

Cash flows from investing activities exclusively reflect cash-effective acquisitions and disposals of investments in intangible assets, property, plant and equipment, non-current financial assets, and changes in term deposits with a maturity of more than 3 months, including commercial papers.

In addition to cash flows resulting from equity items (capitalisation measures and dividend payments), cash flows from financing activities also comprise cash flows arising from changes in financial liabilities.

If cash and cash equivalents include restricted cash, this is reported separately.

→ **Changes in cash flows from financing activities**

Changes in cash flows from financing activities

€ thousands	31 Dec. 2016	Cash-effective		Non-cash	
			Acquisitions	Exchange-rate-related changes	31 Dec. 2017
Non-current liabilities	57,269	-2,122	-	-1,388	53,759
Current liabilities	119,082	-95,491	-	-2,306	21,285
Lease liabilities	1,193	-223	-	-43	927
Total liabilities from financing activities	177,544	-97,386	-	-3,737	75,971
Dividend payments	-	-12,348	-	-	-
Salary conversion (provisions for pensions)	-	4,186	-	-	-
Total cash flows from financing activities	-	-105,998	-	-	-

VIII. SEGMENT REPORTING

Segment reporting is prepared in accordance with IFRS 8 based on the management approach and corresponds to our internal organisational and management structure as well as the reporting lines to the Managing Directors as the chief operating decision-makers. In our matrix organisation, management decisions are primarily taken on the basis of the key performance indicators – order intake, external sales revenue and earnings before interest and taxes (EBIT) – determined for the Pumps, Valves and Service segments. Reporting the relevant assets, number of employees and inter-segment sales revenue for these segments is not part of our internal reporting. The managers in charge of the segments, which are geared to product groups, have profit and loss responsibility. They identify business opportunities across markets and industries and assess our options based on current and future market requirements. They also proactively encourage the development of new products and improvements to the available range of products. In this context, they work closely with our Sales organisation and Operations.

The **Pumps** segment includes single- and multistage pumps, submersible pumps and associated control and drive systems. Applications include process engineering, building services, water and waste water transport, energy conversion and solids transport.

The **Valves** segment covers butterfly, globe, gate, control, diaphragm and ball valves, as well as associated actuators and control systems. Applications primarily include process engineering, building services, energy conversion and solids transport.

The **Service** segment covers the installation, commissioning, start-up, inspection, servicing, maintenance and repair of pumps, related systems and valves for all applications; as well as modular service concepts and system analyses for complete systems.

Our companies can be allocated to one or more segments based on their business activities.

The amounts disclosed for the individual segments have been established in compliance with the accounting policies of the underlying consolidated financial statements.

Transfer prices for intercompany sales are determined on an arm's length basis.

There were no discontinued operations in the period under review, as in the comparative period of the previous year.

The **order intake** by segment presents order intake generated with third parties and non-consolidated Group companies.

The **external sales revenue** by segment presents sales revenue generated with third parties and non-consolidated Group companies.

The table shows **earnings before interest and taxes (EBIT)** and **consolidated earnings before income taxes (EBT)** including non-controlling interests.

→ **Segment reporting**

The EBIT of the Pumps segment includes depreciation and amortisation expense of € 47.0 million (previous year: € 49.2 million), the EBIT of the Valves segment includes depreciation and amortisation expense of € 9.6 million (previous year: € 11.1 million) and the EBIT of the Service segment includes depreciation and amortisation expense of € 14.9 million (previous year: € 12.3 million).

€ 588,997 thousand (previous year: € 552,538 thousand) of the sales revenue presented was generated by the companies based in Germany, € 228,404 thousand (previous year: € 262,601 thousand) by the companies based in France, € 167,274 thousand (previous year: € 200,779 thousand) by the companies based in the USA, and € 1,220,283 thousand (previous year: € 1,149,734 thousand) by the other Group companies.

There were no relationships with individual customers that accounted for a material proportion of Group sales revenue.

At the reporting date, the total non-current assets of the KSB Group amounted to € 636,453 thousand (year-end figure in 2017: € 632,641 thousand), with 204,209 thousand (year-end figure in 2017: € 199,272 thousand) being attributable to the companies based in Germany and € 432,244 thousand (year-end figure in 2017: € 433,369 thousand) being attributable to the other Group companies. They include intangible assets, property, plant and equipment and investments accounted for using the equity method; non-current financial instruments and deferred tax assets are not included.

Segment reporting

€ thousands	Order intake		Sales revenue		EBIT		
	2017	2016	2017	2016	2017	2016	
Pumps segment	1,473,628	1,386,617	1,444,392	1,428,491	79,891	60,876	
Valves segment	343,505	331,182	338,849	360,794	51	8,794	
Service segment	448,179	438,756	421,717	416,521	37,303	33,279	
Reconciliation to PoC	–	–	–	–40,154	–	–14,780	
Total	2,265,312	2,156,555	2,204,958	2,165,652	117,245	88,169	
					Financial income – Interest and similar income	6,139	6,357
					Financial expense – Interest and similar expenses	–19,204	–19,885
					Earnings before income taxes (EBT)	104,180	74,641

IX. OTHER DISCLOSURES**Contingent liabilities (contingencies and commitments)****Contingent liabilities and collateral**

€ thousands	2017	2016
Liabilities from guarantees	4,877	4,481
Liabilities from warranties	482	224
Liabilities from the granting of other security for third-party liabilities and other contingent liabilities	10,696	11,231
	16,055	15,936

Other contingent liabilities are expected to include up to € 1,599 thousand (previous year: € 7,380 thousand) for tax items (plus any interest). At present, there are no indications that any claims will be asserted under these obligations.

The Group has contingent liabilities as a result of its investment in associates and joint ventures of € 7,426 thousand (previous year: € 9,344 thousand). The reported amount is the Group's share of contingent liabilities from joint ventures. Contingent liabilities relating to other investments total € 963 thousand (previous year: € 1,006 thousand). The extent to which these will result in a cash outflow depends on the future business performance of the respective company.

Operating leases

€ thousands	Minimum lease payments	
	2017	2016
Due within 1 year	15,696	16,627
Due between 1 and 5 years	30,069	29,269
Due after more than 5 years	3,941	7,001
	49,706	52,897

In the year under review, € 16,627 thousand (previous year: € 17,832 thousand) was spent.

Operating leases relate primarily to vehicles and real estate.

→ Finance leases

Finance leases relate mostly to real estate, as well as to other equipment, operating and office equipment. The term of the contract covers most of the useful life of the asset concerned.

The annual obligations from IT services agreements amount to € 41,844 thousand (previous year: € 56,243 thousand) over a term of one to five years.

As in the previous year, there are no purchase price obligations from acquisitions of companies and no payment obligations from capitalisation measures at Group companies.

Finance leases

€ thousands	Minimum lease payments		Present values	
	2017	2016	2017	2016
Due within 1 year	359	561	353	501
Due between 1 and 5 years	579	587	574	584
Due after more than 5 years	–	112	–	109
	938	1,260	927	1,194

The aggregate purchase obligation for investments (principally items of property, plant and equipment) amounts to € 12,249 thousand (previous year: € 17,854 thousand). Almost all of the corresponding payments are due in 2018.

Research and development costs

Research and development costs in the year under review amounted to € 47,106 thousand (previous year: € 51,262 thousand). Some of these costs are contract costs under IAS 11.

Related party disclosures

Balances and transactions between KSB SE & Co. KGaA and its subsidiaries, which are related parties, have been eliminated during the consolidation process and are not explained in further detail. Details regarding transactions between the KSB Group and other related parties are provided below.

Other related parties include:

Pursuant to section 21(1) of the *WpHG* [*Wertpapierhandels-gesetz* – German Securities Trade Act], **KSB Stiftung** [KSB Foundation], Stuttgart, notified us on 21 May 2008 that its voting interest in KSB SE & Co. KGaA, Frankenthal/Pfalz exceeded the 75.00 % threshold on 5 May 2008 and amounted to 80.24 % (711,453 voting shares) on this date. 0.54 % of the voting rights (4,782 voting shares) were held directly by KSB Stiftung, Stuttgart, and 79.70 % (706,671 voting shares) were attributable to KSB Stiftung, Stuttgart, pursuant to section 22(1), sentence 1, No. 1 of the *WpHG*. The voting rights attributed to KSB Stiftung, Stuttgart, were held by **Johannes und Jacob Klein GmbH**, Frankenthal. In 2017 the voting interest of Johannes und Jacob Klein GmbH increased to 83.76 %.

Related parties also include the subsidiary companies and joint ventures of Johannes und Jacob Klein GmbH, Frankenthal, as well as the **Kühborth Stiftung GmbH** [Kühborth Foundation], Stuttgart, which holds 1 % of the shares in Johannes und Jacob Klein GmbH. In addition, related parties include the Managing Directors of Johannes und Jacob Klein GmbH, as well as enti-

ties controlled or jointly controlled by the Managing Directors of Johannes und Jacob Klein GmbH.

In the reporting period, related parties also included the Supervisory Board and the Board of Management of KSB, which operated under the legal form of a public limited company under German law [*Aktiengesellschaft*] until the end of the financial year.

The following table shows services provided and used, as well as pending receivables and liabilities owed from and to related parties:

→ **Services, receivables and liabilities in dealings with related parties**

Further information on joint ventures and associates (related party disclosures) can be found in Section IV. Balance Sheet Disclosures – Notes No. 4 “Investments accounted for under the equity method”, No. 6 “Trade receivables and PoC as well as other financial and non-financial assets” and No. 10 “Liabilities”, and in Section IX. Other Disclosures – Contingent Liabilities.

The transactions in relation to the parent company Johannes und Jacob Klein GmbH are based on a rental and services agreement. In addition, Johannes und Jacob Klein GmbH received dividend payments.

Transactions with subsidiaries of Johannes und Jacob Klein GmbH comprise transactions with Palatina Versicherungsservice GmbH, Abacus alpha GmbH, Abacus Resale GmbH, Abacus Experten GmbH and Salinnova GmbH (formerly AIM Separation GmbH). There were no transactions with associates or joint ventures of Johannes und Jacob Klein GmbH in the financial year.

A rental and services agreement for insurances is in place between Palatina Versicherungsservice GmbH and KSB SE & Co. KGaA. Abacus Experten GmbH concluded a number of service

Services, receivables and liabilities in dealings with related parties

€ thousands	Sales of goods and services		Purchases of goods and services		Receivables		Liabilities	
	2017	2016	2017	2016	31 Dec. 2017	31 Dec. 2016	31 Dec. 2017	31 Dec. 2016
KSB Stiftung and Kühborth-Stiftung GmbH	–	–	–	–	–	–	–	–
Johannes und Jacob Klein GmbH (formerly: Klein Pumpen GmbH)	1,708	143	16	35	4	133	16	–
Subsidiaries of Johannes und Jacob Klein GmbH	1,448	75	2,845	765	182	124	774	214
Associates / joint ventures of Johannes und Jacob Klein GmbH	–	483	–	2,172	–	–	–	25
Other related parties (corporate bodies), excluding "Management remuneration"	105	12	16	16	6	1	–	–

agreements with KSB SE & Co. KGaA; there is a framework delivery and service agreement with Abacus Resale GmbH for the purchase of returns and the provision of additional associated services. In addition, products were delivered to the company as part of the normal business activities. KSB SE & Co. KGaA and Abacus alpha GmbH have also concluded service agreements. Our products were delivered to airnotec GmbH and Salinnova GmbH as part of normal business activities. We purchased spare parts from Salinnova GmbH. In the financial year, two Supervisory Board members held an immaterial share of interests in our company.

Transactions with related parties are, as a rule, performed at arm's length. Transactions that initially were not performed at arm's length in the 2017 financial year were compensated in the financial year.

Until the end of the 2017 financial year, the company was granted reimbursements under agreements for the compensation of dis-

advantages concluded with Johannes und Jacob Klein GmbH as well as related and other parties, amounting to € 2.5 million for rental and services transactions. They were recorded under other operating income. € 0.1 million of these relate to the period from January to April 2017, € 2.1 million to the financial years from 2006 to 2016 and € 0.3 million to cost reimbursements in connection with tax issues. This resulted in tax liabilities including interest amounting to a total of € 5.1 million for the financial years from 2007 to 2016, with a final settlement being agreed with the fiscal authorities. A major share of this amount was already paid in the 2017 financial year. Within the scope of ongoing legal investigations commissioned by the company, further claims of the company exceeding the volume covered by the agreements already made in financial years 2016 and 2017 are being reviewed by an external legal consultancy firm.

Pending balances at the year end are unsecured, do not accrue interest and are settled by means of payments. No guarantees were given or received. The receivables presented here, as in the

previous year, are not subject to write-downs and no provisions have been created for this purpose.

Disclosures and information on affiliates and investments accounted for using the equity method provided in other section of these Notes refer to relations covering the supply of products and services on an arm's length basis, unless stated otherwise.

Pursuant to IAS 24, the remuneration of key management personnel of the Group must be disclosed. The following table contains the relevant figures for the KSB Group with regard to the remuneration paid to members of the Board of Management of KSB, which operated under the legal form of a public limited company under German law [*Aktiengesellschaft*] until the end of the financial year.

Management remuneration

€ thousands	31 Dec. 2017	31 Dec. 2016
Short-term benefits (total remuneration)	1,858	1,250
Post-employment benefits	1,422	1,388
Other long-term benefits	–	–
Termination benefits	–	–
Share-based payments	–	–
Total	3,280	2,638

Based on the relevant legal provisions, the Annual General Meeting on 6 May 2015 resolved not to disclose the remuneration of the Board of Management separately for each member and classified by components. € 2,934 thousand (previous year: € 5,255 thousand) has been provided for pension obligations to active members of the Board of Management as at 31 Dec. 2017, and € 42,202 thousand (previous year: € 39,309 thou-

sand) to former members of the Board of Management and their surviving dependants; total benefits paid to these persons amounted to € 2,422 thousand in the year under review (previous year: € 2,244 thousand).

The short-term benefits paid to members of the Supervisory Board amount to € 834 thousand for the 2017 financial year (previous year: € 716 thousand).

The members of the Supervisory Board and the Board of Management are listed before the presentation of the proposal on the appropriation of the net retained earnings of KSB AG.

Auditors

PricewaterhouseCoopers GmbH Wirtschaftsprüfungsgesellschaft, based in Frankfurt am Main with an office in Mannheim, were appointed as auditors and group auditors for the 2017 financial year at the Annual General Meeting of KSB SE & Co. KGaA on 10 May 2017. Overall, fees (including expenses) amounting to € 1,334 thousand were recognised as expenses. Of this, € 1,086 thousand relates to audit services, € 49 thousand to other assurance services and € 199 thousand to other services.

KSB applied the IDW RS HFA 36 (new version) standard for the financial year ending on 31 December 2016, i.e. earlier than required. The audit fees include costs for the audit of the consolidated financial statements and of the statutory annual financial statements of KSB SE & Co. KGaA and the German subsidiaries included in the consolidated financial statements. The fees for other certification services primarily include attestation services outside of the audit of the annual financial statements. The fees for other services mainly include fees for project-specific consultancy services.

Use of exemption option

KSB Service GmbH, Frankenthal, KSB Service GmbH, Schwedt and Uder Elektromechnik GmbH, Friedrichsthal, have made partial use of the exemption provision under section 264(3) of the *HGB*.

Events after the reporting period

The Annual General Meeting of KSB SE & Co. KGaA adopted a resolution on 10 May 2017 on the announced change in the legal form of the company to a partnership limited by shares [*Kommanditgesellschaft auf Aktien* – KGaA]. An entry was made to that effect in the *Handelsregister* [German Commercial Register] on 17 January 2018.

No further significant events occurred after the balance sheet date that would have a material effect on the company's results of operations, financial position and net assets.

German Corporate Governance Code

The Managing Directors and the Supervisory Board of KSB SE & Co. KGa issued the current statement of compliance with the recommendations of the Government Commission on the German Corporate Governance Code in accordance with section 161 of the *AktG* [*Aktiengesetz* – German Public Companies Act] on 21 March 2018. The statement of compliance is published on our web site (www.ksb.com) and has thus been made permanently accessible.

LIST OF SHAREHOLDINGS

Affiliates (national and international)

No.	Name and seat	Country	Capital share in %	Held by No.
National				
1	Dynamik-Pumpen GmbH, Stuhr	Germany	100.00	
2	KAGEMA Industrieausrüstungen GmbH, Pattensen	Germany	100.00	
3	KSB Armaturen Verwaltungs- und Beteiligungs-GmbH, Frankenthal	Germany	100.00	
4	KSB Service GmbH, Frankenthal	Germany	100.00	
5	KSB Service GmbH, Schwedt	Germany	100.00	
6	PAB Pumpen- und Armaturen-Beteiligungsges. mbH, Frankenthal	Germany	51.00	
7	PMS-BERCHEM GmbH, Neuss	Germany	100.00	
8	Pumpen-Service Bentz GmbH, Reinbek	Germany	100.00	
9	Uder Elektromechanik GmbH, Friedrichsthal	Germany	100.00	
International				
10	Aplicaciones Mecánicas Válvulas Industriales, S.A. (AMVI), Burgos	Spain	100.00	27
11	Canadian Kay Pump Limited, Mississauga / Ontario	Canada	100.00	
12	Dalian KSB AMRI Valves Co., Ltd., Dalian	China	100.00	27
13	DP industries B.V., Alphen aan den Rijn	The Netherlands	100.00	26
14	FORTY FOUR ACTIVIA PARK (PTY) LTD, Germiston (Johannesburg)	South Africa	100.00	49
15	GIW Industries, Inc., Grovetown / Georgia	USA	100.00	17
16	Hydroskepi GmbH, Amaroussion (Athens)	Greece	100.00	
17	KSB America Corporation, Richmond / Virginia	USA	100.00	6
18	KSB AMRI Inc., Houston / Texas	USA	10.03	57
			89.97	17
19	KSB Australia Pty Ltd, Bundamba QLD	Australia	100.00	27
20	KSB Belgium S.A., Bierges-lez-Wavre	Belgium	100.00	27
21	KSB BRASIL LTDA., Várzea Paulista	Brazil	100.00	27
22	KSB, Bombas e Válvulas, SA, Albarraque	Portugal	95.00	
23	KSB Chile S.A., Santiago	Chile	100.00	
24	KSB Compañía Sudamericana de Bombas S.A., Carapachay (Buenos Aires)	Argentina	95.00	27
			5.00	
25	KSB de Mexico, S.A. de C.V., Querétaro	Mexico	100.00	
26	KSB Finance Nederland B.V., Zwanenburg	The Netherlands	100.00	27
27	KSB FINANZ S.A., Echternach	Luxembourg	100.00	
28	KSB Finland Oy, Kerava	Finland	100.00	
29	KSB, Inc., Richmond / Virginia	USA	100.00	17
30	KSB, Inc. – Western Division, Bakersfield / California	USA	100.00	17
31	KSB Italia S.p.A., Milan	Italy	100.00	27
32	KSB ITUR Spain S.A., Zarautz	Spain	100.00	27
33	KSB Korea Ltd., Seoul	South Korea	100.00	
34	KSB Limited, Hong Kong	China	100.00	
35	KSB Limited, Loughborough	United Kingdom	100.00	27

Notes

List of Shareholdings

No.	Name and seat	Country	Capital share in %	Held by No.
36	KSB Malaysia Pumps & Valves Sdn. Bhd., Shah Alam	Malaysia	100.00	63
37	KSB Middle East FZE, Dubai	U.A.E.	100.00	27
38	KSB MIL Controls Limited, Annamanada	India	49.00 51.00	54
39	KSB Sverige Aktiebolag AB, Gothenburg	Sweden	100.00	
40	KSB Nederland B.V., Zwanenburg	The Netherlands	100.00	26
41	KSB New Zealand Limited, Albany / Auckland	New Zealand	100.00	19
42	KSB Norge AS, Ski	Norway	100.00	
43	KSB Österreich Gesellschaft mbH, Vienna	Austria	100.00	27
44	KSB PHILIPPINES, INC., Makati City	Philippines	100.00	63
45	KSB-Pompa, Armatür Sanayi ve Ticaret A.S., Ankara	Turkey	100.00	27
46	KSB POMPES ET ROBINETTERIES S.à.r.l. d'Associé unique, Casablanca	Morocco	100.00	57
47	KSB Pompy i Armatura Sp. z o.o., Ozarow-Mazowiecki	Poland	100.00	
48	KSB Pump & Valve Technology Service (Tianjin) Co., Ltd, Tianjin	China	100.00	34
49	KSB Pumps and Valves (Pty) Ltd., Germiston (Johannesburg)	South Africa	84.99	55
50	KSB Pumps and valves L.t.d., Domžale	Slovenia	100.00	
51	KSB Pumps Co. Ltd., Bangkok	Thailand	40.00	
52	KSB Pumps Company Limited, Lahore	Pakistan	58.89	
53	KSB Pumps Inc., Mississauga / Ontario	Canada	100.00	27
54	KSB Pumps Limited, Pimpri (Pune)	India	40.54	11
55	KSB Pumps (S.A.) (Pty) Ltd., Germiston (Johannesburg)	South Africa	100.00	27
56	KSB-Pumpy+Armatury s.r.o., koncern, Prague	Czech Republic	100.00	
57	KSB S.A.S., Gennevilliers (Paris)	France	100.00	27
58	KSB Seil Co., Ltd., Busan	South Korea	100.00	
59	KSB Service Belgium S.A./N.V., Bierges-lez-Wavre	Belgium	100.00	20
60	KSB Service EITB-SITELEC S.A.S., Montfavet	France	100.00	57
61	KSB Service Energie S.A.S.U., Rambervillers	France	100.00	57
62	KSB Shanghai Pump Co., Ltd., Shanghai	China	80.00	27
63	KSB Singapore (Asia Pacific) Pte Ltd, Singapore	Singapore	100.00	
64	KSB Szivattyú és Armatura Kft., Budapest	Hungary	100.00	
65	KSB Taiwan Co., Ltd., New Taipei City	Taiwan	100.00	
66	KSB Tech Pvt. Ltd., Pimpri (Pune)	India	100.00	
67	KSB Valves (Changzhou) Co., Ltd., Jiangsu	China	100.00	
68	KSB Verwaltung (Schweiz) AG, Reinach	Switzerland	100.00	27
69	KSB Vietnam Co., Ltd, Long Thanh District	Vietnam	100.00	63
70	KSB (Schweiz) AG, Oftringen	Switzerland	100.00	
71	KSB SERVICE COTUMER S.A.S., Déville lès Rouen	France	100.00	61
72	OOO "KSB", Moscow	Russia	100.00	3
73	PT. KSB Indonesia, Cibitung	Indonesia	94.10 5.90	27
74	PT. KSB Sales Indonesia, Cibitung	Indonesia	99.00 1.00	73

No.	Name and seat	Country	Capital share in %	Held by No.
75	PUMPHUSET Sverige AB, Sollentuna	Sweden	100.00	39
76	REEL s.r.l., Ponte di Nanto	Italy	100.00	
77	SISTO Armaturen S.A., Echternach	Luxembourg	52.85	27
78	Smedegaard Pumps Limited, Bridgwater	United Kingdom	100.00	35
79	Société de travaux et Ingénierie Industrielle S.A.S., Déville lès Rouen	France	100.00	71
80	SPI Energie S.A.S., La Ravoire	France	100.00	57
81	Standard Alloys Incorporated, Port Arthur / Texas	USA	100.00	17
82	VM Pumpar AB, Gothenburg	Sweden	100.00	39

Joint ventures (national and international)

No.	Name and seat	Country	Capital share in %	Held by No.	Equity* € thousands	Net profit/ loss for the year* € thousands
National						
83	Nikkiso-KSB GmbH, Pegnitz	Germany	50.00		-455	40 ■
International						
84	KSB MOTOR TEKNOLOJİLERİ SANAYİ VE TİCARET ANONİM ŞİRKETİ, Ankara	Turkey	55.00	45	101	-5
85	KSB Pumps Arabia Ltd., Riyadh	Saudi Arabia	50.00	27	15,286	1,192
86	KSB Service LLC, Abu Dhabi	U.A.E.	49.00		6,715	437
87	Shanghai Electric-KSB Nuclear Pumps and Valves Co., Ltd., Shanghai	China	45.00		28,886	977

Associates (national and international)

No.	Name and seat	Country	Capital share in %	Held by No.	Equity* € thousands	Net profit/ loss for the year* € thousands
International						
88	Motori Sommersi Riavvolgibili S.r.l., Cedegolo	Italy	25.00		4,661	2,333

* Data according to latest annual financial statements under IFRS

■ Prior-period figures

Notes
List of Shareholdings

Companies not consolidated because of immateriality – Affiliates (national and international)

No.	Name and seat	Country	Capital share in %	Held by No.	Equity* € thousands	Net profit/ loss for the year* € thousands
National						
89	gear-tec GmbH, Eggebek	Germany	51.00		327	-7
90	Pumpen Partner Netzwerk UG, Stein	Germany	51.00	4	2	0
International						
91	I000 "KSB BEL", Minsk	Belarus	98.10 1.90	72 3	481	171
92	KSB Algérie Eurl, Bordj el Kifane (Alger)	Algeria	100.00	27	794	318 ■
93	KSB Čerpadlá a Armatúry, s.r.o., Bratislava	Slovakia	100.00		332	5 ■
94	KSB Colombia SAS, Funza (Cundinamarca)	Colombia	100.00	27	584	7
95	KSB Ltd., Tokyo	Japan	100.00		-1,658	-483
96	KSB Perú S.A., Lurin	Peru	100.00		1,210	55 ■
97	KSB Pumpe i Armatuře d.o.o. Beograd, Belgrade	Serbia	100.00	50	56	-3 ■
98	KSB pumpe i armature d.o.o., Rakov Potok	Croatia	100.00	50	150	42 ■
99	KSB ZAMBIA LIMITED, Kitwe	Zambia	60.00	55	2	4
100	Techni Pompe Service Maroc (TPSM), Casablanca	Morocco	100.00	46	-482	-41 ■
101	TOO "KSB Kazakhstan", Almaty	Kazakhstan	100.00	72	137	87
102	TOV "KSB Ukraine", Kiev	Ukraine	100.00	72	293	112

* Data according to latest annual financial statements under IFRS

■ Prior-period figures

SUPERVISORY BOARD

Dr. Wolfgang Kühborth, Dipl.-Ing., Frankenthal
Honorary Chairman of the Supervisory Board
(† 31 Jan. 2017)

Dr. Thomas Seeberg, Dipl.-Kfm., Icking¹⁾
Former Managing Director of OSRAM GmbH
(Chairman of the Supervisory Board until 28 Feb. 2017)

Dr. Bernd Flohr, Dipl.-Kfm., Dipl.-Soz., Geislingen
Former Executive Board Member of WMF AG
(Chairman of the Supervisory Board since 22 March 2017)

Alois Lautner, Lathe Operator, Kirchentumbach²⁾
Deputy Chairman of the Pegnitz Works Council
(Deputy Chairman of the Supervisory Board)

Dr. Stella A. Ahlers, Kauffrau, Feusisberg, Switzerland³⁾
Chairwoman of the Board of Management of Ahlers AG
(Member of the Supervisory Board from 11 May 2016 to 20 March 2017)

Dr. Martin Auer, Mannheim⁴⁾
Head of Corporate Legal, Compliance, Procurement and Logistic Services
MVV Energie AG
(Member of the Supervisory Board until 28 Feb. 2017)

Dr.-Ing. Stephan Bross, Freinsheim⁵⁾
Head of Corporate Unit Pumps
(Member of the Supervisory Board until 14 Sept. 2017)

Oswald Bubel, Dipl.-Betriebswirt, Saarbrücken
Managing Director of Hager Electro GmbH & Co. KG
(Member of the Supervisory Board from 21 March 2017 to 31 Jan. 2018)

Klaus Burchards, Dipl.-Kfm., Stuttgart
Independent Auditor
(Member of the Supervisory Board since 18 April 2017)

Arturo Esquinca, Dipl.-Chemieing., Forch, Switzerland
Coesia Group, Industrial Process Division, Zurich, Switzerland
Head of Business Development
(Member of the Supervisory Board since 26 Feb. 2018)

Dr. Jörg Matthias Großmann, Dipl.-Kfm., Großhesselohe⁶⁾
Member of the Management/CFO of
Freudenberg Chemical Specialities SE & Co. KG
(Member of the Supervisory Board until 14 April 2017)

René Klotz, NC Programmer, Frankenthal
Chairman of the General Works Council

Wolfgang Kormann, Hand Moulder, Pegnitz
Member of the European Works Council,
Chairman of the Group Works Council

Klaus Kühborth, Dipl.-Wirtsch.Ing., Frankenthal
Managing Director of Johannes und Jacob Klein GmbH

Monika Kühborth, Editor, Homburg
Managing Director of Klein, Schanzlin & Becker GmbH
(Member of the Supervisory Board from 21 March 2017 to 31 Jan. 2018)

Birgit Mohme, Industrial Business Management Assistant, Frankenthal⁷⁾
Trade Union Secretary of IG Metall Ludwigshafen-Frankenthal

Volker Seidel, Electrical and Electronics Installer, Münchenberg
1. Delegate of IG Metall Ostoberfranken

Prof. Dr.-Ing. Corinna Salander, Stuttgart⁸⁾
Head of Railway Vehicle Technology, Stuttgart University
(Member of the Supervisory Board since 26 Feb. 2018)

Gabriele Sommer, Dipl.-Geol., Wörthsee⁹⁾
Global Head of Human Resources TÜV SÜD AG

Dr. Hans-Stefan Wiß, Ludwigshafen
Head of Legal & Compliance, KSB SE & Co. KGaA
(Member of the Supervisory Board since 15 Sept. 2017)

**Mandates of KSB Supervisory Board members on the
Supervisory Board / Board of Directors of other companies**

- ¹⁾ Member of the Board of Trustees of WTS-Stiftung für Altersversorgung, Munich, Germany
- ²⁾ BKK advita, Alzey, Germany
- ³⁾ Adolf Ahlers AG, Zug, Switzerland
- ⁴⁾ PALATINA Versicherungsservice GmbH, Frankenthal, Germany
Stadtwerke Ingolstadt Beteiligungs GmbH, Ingolstadt, Germany
- ⁵⁾ Burckhardt Compression AG, Winterthur, Switzerland
- ⁶⁾ Klüber Lubrication München SE & Co. KG, Munich, Germany
Klüber Lubrication India Pvt. Ltd., Bangalore, India
FCS Holding Inc., Wilmington, USA
Chem-Trend Holding LP, Wilmington, USA
Externa Holding S.R.L., Milan, Italy
- ⁷⁾ Deutsche Rentenversicherung Rheinland-Pfalz, Speyer, Germany
- ⁸⁾ Supervisory Board, Bombardier Transportation GmbH
Scientific Committee Shift2Rail
Group of publishers of *Eisenbahntechnische Rundschau* (ETR)
Scientific Advisory Council of ZEVrail
University bodies
Chair of the Doctoral Candidate Admissions Committee of Faculty 7
Spokesperson of the Centre for Transportation Research of Stuttgart University (FOVUS)
Member of the Research / Young Scientists and Equal Opportunities senate committees
Deputy Equal Opportunities Officer of Stuttgart University
- ⁹⁾ TÜV SÜD Industrie Service GmbH, Munich, Germany
TÜV SÜD Auto Service GmbH, Stuttgart, Germany

LEGAL REPRESENTATIVES

Managing Directors of KSB Management SE (from 17 January 2018, previously: Board of Management of KSB Aktiengesellschaft)

Dr.-Ing. Peter Buthmann, Frankenthal¹⁾ (until 31 Dec. 2017)
Human Resources Director
Technology, Production, Sales, Purchasing, Human Resources
and the Pumps and Valves segments

Werner Stegmüller, Mannheim²⁾ (until 30 May 2017)
Finance and Accounting, Controlling,
Communications, Investor Relations, IT, Patents & Trademarks,
Legal & Compliance, Internal Audits and the Service segment

Dr. Matthias Schmitz, Frankenthal³⁾ (from 1 June 2017)
Finance, Controlling, Investor Relations, IT, Purchasing

Ralf Kannefuss, Regensburg⁴⁾ (from 1 July 2017)
Sales, Service

Dr. Stephan Bross, Freinsheim⁵⁾ (from 15 Sept. 2017)
Technology, Products, Operations, Digital Transformation

Dr. Stephan Jörg Timmermann, Augsburg (from 13 Nov. 2017)
Sprecher [Chairman]
Strategy, Human Resources, Communications, Legal & Compliance

Mandates of the Managing Directors on the Board of Directors of KSB companies

¹⁾ SISTO Armaturen S.A., Echternach, Luxembourg
KSB FINANZ S.A., Echternach, Luxembourg
KSB Pumps (S.A.) (Pty) Ltd., Germiston (Johannesburg), South Africa (until 31 May 2017)
KSB Pumps and Valves (Pty) Ltd., Germiston (Johannesburg), South Africa (until 31 May 2017)

²⁾ KSB Finanz S.A., Echternach, Luxembourg
KSB Finance Nederland B.V., Zwanenburg, The Netherlands
Canadian Kay Pump Limited, Mississauga / Ontario, Canada
KSB America Corporation, Richmond / Virginia, USA
KSB Pumps Limited, Pimpri (Pune), India
KSB Shanghai Pump Co., Ltd., Shanghai, China
Shanghai Electric-KSB Nuclear Pumps and Valves Co., Ltd., Shanghai, China
KSB Bombas Hidráulicas S.A., Várzea Paulista, Brazil
GIW Industries, Inc., Grovetown / Georgia, USA
KSB, Inc., Richmond / Virginia, USA

³⁾ KSB Finanz S.A., Echternach, Luxembourg
KSB Finance Nederland B.V., Zwanenburg, The Netherlands
Canadian Kay Pump Limited, Mississauga / Ontario, Canada
KSB America Corporation, Richmond / Virginia, USA (from 7 July 2017)
KSB Pumps Limited, Pimpri (Pune), India (from 25 July 2017)
KSB Shanghai Pump Co., Ltd., Shanghai, China
Shanghai Electric-KSB Nuclear Pumps and Valves Co., Ltd., Shanghai, China
GIW Industries, Inc., Grovetown / Georgia, USA

⁴⁾ SISTO Armaturen S.A., Echternach, Luxembourg (from 20 Feb. 2018)
KSB Shanghai Pump Co., Ltd., Shanghai, China

⁵⁾ KSB Pumps Limited, Pimpri (Pune), India
KSB Pumps (S.A.) (Pty) Ltd., Germiston (Johannesburg), South Africa
KSB Pumps and Valves (Pty) Ltd., Germiston (Johannesburg), South Africa
Gate Motor Teknolojileri Sanayi ve Ticaret A.S., Turkey
DP industries B.V., Alphen, The Netherlands (until 31 Dec. 2017)

Notes

Legal Representatives
Proposal on the Appropriation of the
Net Retained Earnings of KSB SE & Co. KGaA

PROPOSAL ON THE APPROPRIATION OF THE NET RETAINED EARNINGS OF KSB SE & Co. KGaA

We will propose to the Annual General Meeting that the net retained earnings of € 13,359,777.62 of KSB SE & Co. KGaA be appropriated as follows:

Distribution of a dividend of € 7.50 per ordinary no-par-value share	€ 6,649,612.50
and, in accordance with the Articles of Association, € 7.76 per preference no-par-value share	€ 6,710,165.12

Frankenthal, 21 March 2018

KSB Management SE

The Managing Directors

The annual financial statements of KSB SE & Co. KGaA were prepared in accordance with German accounting principles. They are published in the *Bundesanzeiger* [German Federal Gazette]. The annual financial statements can also be downloaded from our web site at www.ksb.com, or sent in print form on request.



GENERAL INFOR- MATION

164	Responsibility Statement
165	Independent Auditor's Report
175	Glossary
176	Contacts

RESPONSIBILITY STATEMENT

To the best of our knowledge, and in accordance with the applicable reporting principles, the consolidated financial statements give a true and fair view of the assets, liabilities, financial position and profit or loss of the Group, and the group management report includes a fair review of the development and performance of the business and the position of the Group, together with a description of the principal opportunities and risks associated with the expected development of the Group.

Frankenthal, 21 March 2018

KSB Management SE

The Managing Directors

INDEPENDENT AUDITOR'S REPORT

To KSB SE & Co. KGaA, Frankenthal/Pfalz

REPORT ON THE AUDIT OF THE CONSOLIDATED FINANCIAL STATEMENTS AND OF THE GROUP MANAGEMENT REPORT

AUDIT OPINIONS

We have audited the consolidated financial statements of KSB SE & Co. KGaA (formerly KSB Aktiengesellschaft), Frankenthal/Pfalz, and its subsidiaries (the Group), which comprise the statement of financial position as at 31 December 2017, and the statement of comprehensive income, statement of changes in equity and statement of cash flows for the financial year from 1 January to 31 December 2017, and notes to the consolidated financial statements, including a summary of significant accounting policies. In addition, we have audited the group management report of KSB SE & Co. KGaA for the financial year from 1 January to 31 December 2017. We have not audited the content of those parts of the group management report listed in the "Other Information" section of our auditor's report in accordance with the German legal requirements.

In our opinion, on the basis of the knowledge obtained in the audit,

- the accompanying consolidated financial statements comply, in all material respects, with the IFRSs as adopted by the EU, and the additional requirements of German commercial law pursuant to § [Article] 315e Abs. [paragraph] 1 HGB [Handelsgesetzbuch: German Commercial Code] and, in compliance with these requirements, give a true and fair view of the assets, liabilities, and financial position of the Group as at 31 December 2017, and of its financial performance for the financial year from 1 January to 31 December 2017 and
- the accompanying group management report as a whole provides an appropriate view of the Group's position. In all material respects, this group management report is consistent with the consolidated financial statements, complies with German legal requirements and appropriately presents the opportunities and risks of future development. Our audit opinion on the group management report does not cover the content of those parts of the group management report listed in the "Other Information" section of our auditor's report.

Pursuant to § 322 Abs. 3 Satz [sentence] 1 HGB, we declare that our audit has not led to any reservations relating to the legal compliance of the consolidated financial statements and of the group management report.

BASIS FOR THE AUDIT OPINIONS

We conducted our audit of the consolidated financial statements and of the group management report in accordance with § 317 HGB and the EU Audit Regulation (No. 537/2014, referred to subsequently as "EU Audit Regulation") and in compliance with German Generally Accepted

Standards for Financial Statement Audits promulgated by the Institut der Wirtschaftsprüfer [Institute of Public Auditors in Germany] (IDW). Our responsibilities under those requirements and principles are further described in the “Auditor's Responsibilities for the Audit of the Consolidated Financial Statements and of the Group Management Report” section of our auditor’s report. We are independent of the group entities in accordance with the requirements of European law and German commercial and professional law, and we have fulfilled our other German professional responsibilities in accordance with these requirements. In addition, in accordance with Article 10 (2) point (f) of the EU Audit Regulation, we declare that we have not provided non-audit services prohibited under Article 5 (1) of the EU Audit Regulation. We believe that the audit evidence we have obtained is sufficient and appropriate to provide a basis for our audit opinions on the consolidated financial statements and on the group management report.

KEY AUDIT MATTERS IN THE AUDIT OF THE CONSOLIDATED FINANCIAL STATEMENTS

Key audit matters are those matters that, in our professional judgment, were of most significance in our audit of the consolidated financial statements for the financial year from 1 January to 31 December 2017. These matters were addressed in the context of our audit of the consolidated financial statements as a whole, and in forming our audit opinion thereon; we do not provide a separate audit opinion on these matters.

In our view, the matters of most significance in our audit were as follows:

- 1 Recoverability of goodwill**
- 2 Accounting treatment for customer-specific construction contracts**
- 3 Recognition and presentation of transactions with “related parties”**

Our presentation of these key audit matters has been structured in each case as follows:

- 1 Matter and issue
- 2 Audit approach and findings
- 3 Reference to further information

Hereinafter we present the key audit matters:

1 Recoverability of goodwill

- 1 In the Company’s consolidated financial statements goodwill amounting in total to EUR 70.5 million is reported under the “Intangible assets” balance sheet item. Goodwill is tested for impairment by the Company once a year or when there are indications of impairment to determine any possible need for write-downs. Impairment testing is carried out at the level

of the cash-generating units to which the relevant goodwill is allocated. The carrying amount of the relevant cash-generating unit, including goodwill, is compared with the corresponding recoverable amount in the context of the impairment test. The recoverable amount is generally calculated on the basis of the value in use, and in one case on the basis of the fair value less costs of disposal. The present value of the future cash flows from the respective cash-generating unit normally serves as the basis of valuation. The present values are calculated using discounted cash flow models. For this purpose, the adopted medium-term business plan of the Group forms the starting point which is extrapolated based on assumptions about long-term rates of growth. Expectations relating to future market developments and assumptions about the development of macroeconomic factors are also taken into account. The discount rate used is the weighted average cost of capital for the relevant cash-generating unit. The impairment test resulted in the recognition of a write-down amounting to a total of EUR 5.6 million with respect to the cash-generating unit KSB Seil Co. Ltd., Busan/South Korea. The outcome of this valuation is dependent to a large extent on the estimates made by the executive directors with respect to the future cash inflows from the respective cash-generating unit, on the discount rate used, the rate of growth as well as other assumptions, and is therefore subject to considerable uncertainty. Against this background and due to the complex nature of the valuation, this matter was of particular significance in the context of our audit.

- ② As part of our audit, we assessed the methodology employed for the purposes of performing the impairment test, among other things. After matching the future cash inflows used for the calculation against the adopted medium-term business plan of the Group, we assessed the appropriateness of the calculation, in particular by reconciling it with general and sector-specific market expectations. We also assessed the appropriate consideration of the costs of Group functions. In the knowledge that even relatively small changes in the discount rate applied can have a material impact on the value of the entity calculated using this method, we focused our testing in particular on the parameters used to determine the discount rate applied, and assessed the calculation model. We evaluated the sensitivity analyses performed by the Company, in order to reflect the uncertainty inherent in the projections. We evaluated that the necessary disclosures were made in the notes relating to cash-generating units for which a reasonably possible change in an assumption would result in the recoverable amount falling below the carrying amount of the cash-generating units including the allocated goodwill.

Overall, the measurement parameters and assumptions used by the executive directors are in line with our expectations and are also within the ranges considered by us to be reasonable.

- ③ The Company's disclosures on goodwill are contained in section IV. note 1 of the notes to the consolidated financial statements.

2 Accounting treatment for customer-specific construction contracts

- 1 Revenue totaling EUR 376.5 million reported in the consolidated financial statements of KSB SE & Co. KGaA is attributable to customer-specific construction contracts. Provided that the criteria of IAS 11 have been met, the revenue is recognized in accordance with the percentage-of-completion method, with the estimate of the stage of completion being based on the ratio of contract costs actually incurred to the planned total costs (“cost-to-cost method”). In particular, estimating the planned total costs and appropriately allocating the costs actually incurred to the contracts are based on the estimates and assumptions made by the executive directors. Against this background and due to the resulting uncertainties and the complexity of the accounting treatment, this matter was of particular significance in the context of our audit.
- 2 During our audit we assessed the processes and controls established by the Group in relation to recognizing revenue from customer-specific construction contracts taking into account the stage of completion. In addition, we examined projects on a sample basis to determine whether they met the requirements for the recognition of revenue in accordance with the percentage of completion pursuant to IAS 11. Moreover, we evaluated the determination of the stage of completion of customer-specific contracts on the basis of the cost-to-cost method and the resulting proportion of revenue recognized, considering that a prospective loss must be recognized immediately. In this connection we assessed the calculation of not only the planned total costs but also the costs actually incurred. We assessed the stage of completion, among other things based on interviews with project managers and by inspecting project documentation. In addition, we assessed the consistency of the methods used to calculate the costs incurred. Furthermore, we addressed the inherent audit risk in this audit area by audit procedures that were consistently carried out throughout the Group. We were able to satisfy ourselves that overall the established systems and processes as well as controls in place are appropriate and that the estimates and assumptions made by the executive directors concerning the recognition and measurement of revenue according to the stage of completion are appropriately documented.
- 3 The Company’s disclosures regarding revenue from customer-specific construction contracts are contained in sections III., IV. note 6 and section V. note 11 of the notes to the consolidated financial statements.

3 Recognition and presentation of transactions with "related parties"

- 1 In the financial year 2017, the Group generated revenue from the sale of goods and services with related parties and incurred expenses from the sale of goods and services. The definition of related parties pursuant to IAS 24 includes both entities and natural persons that are directly or indirectly controlled or significantly influenced by KSB SE & Co. KGaA, as well as entities and natural persons that directly or indirectly control, or exert significant influence over, KSB SE & Co. KGaA (hereinafter referred to as "related parties"). Legal transactions with related parties are generally executed at arm's length. The Company has made disclosures in the consolidated financial statements on legal transactions that were not originally executed at arm's length in the financial year 2017 but were compensated for in the course of the financial year.

By the end of the financial year 2017, the Company had received reimbursements from agreements on compensation for disadvantages in the amount of EUR 2.5 million, which were recognized in "other operating income". EUR 0.1 million of this amount relates to the period from January to April 2017, EUR 2.1 million relates to the financial years from 2006 to 2016 and EUR 0.3 million relates to cost reimbursements for tax processing. An external law firm was involved in the calculation of the compensation for disadvantages and the assertion of the claims. This resulted in tax obligations including interest in the total amount of EUR 5.1 million for the years from 2007 to 2016 that were agreed as part of an actual agreement with the tax authorities based on an expert opinion prepared by an external tax consultancy firm. As part of legal investigations commissioned by the Company which are still ongoing, other claims of the Company extending beyond the agreements already reached in the financial years 2016 and 2017 will be assessed by an external law firm.

Against this background and given the risk that not all transactions with related parties have been recognized by the Company, or that the disclosures on the related parties in the consolidated financial statements are incomplete or incorrect, this matter was of particular significance during our audit.

- 2 As part of our audit, initially we conducted discussions with the executive directors and the legal department of KSB SE & Co. KGaA to obtain an understanding of the establishment of the organizational measures used to identify and approve the conclusion of agreements with related parties, as well as the controls established by the Company in this regard, and assessed these measures and controls. Furthermore, we obtained a full list of all agreements and business relationships with related parties from the executive directors of KSB SE & Co KGaA. We obtained letters of confirmation from the supervisory board members of KSB SE & Co. KGaA in office in the financial year 2017, the managing directors of KSB Management SE (as the former members of the Board of Management of KSB Aktienge-

sellschaft as the Company's legal predecessor) and KSB Stiftung, Kühborth Stiftungs GmbH and Johannes und Jacob Klein GmbH (formerly Klein Pumpen GmbH) as parent companies, in which they list the business relationships, both those in line with the arm's length principle and those not in line with the arm's length principle, with KSB SE & Co. KGaA in the financial year 2017. By comparing the full list of the agreements and business relationships with the related parties against the customer and vendor accounts set up in the financial accounting records of KSB SE & Co. KGaA, we examined whether there were any other business relationships with related parties not specified by the Company. We also examined that the new agreements concluded with the related parties in the financial year since May 2017 had been approved by the supervisory board. We also evaluated that agreements with related parties that were not concluded at arm's length in the previous years and up until April 2017 were terminated or adjusted to reflect standard market conditions in the financial year 2017. We assessed the controls established by the Company to evaluate agreements with related parties for adherence to the arm's length principle prior to a contract conclusion. We assessed the Company's calculations on the disadvantages suffered by it, which were taken as a basis for the agreements on compensation for disadvantages. In addition, we compared the incoming payments at KSB SE & Co KGaA with these agreements. With regard to the recognition of possible risks resulting from legal disputes and tax risks, we also obtained confirmations from attorneys and tax consultants as at 31 December 2017. Based on our audit procedures, we were able to satisfy ourselves that the estimates and assumptions made by the executive directors relating to the disclosures on transactions with related parties are substantiated and sufficiently documented.

- ☒ The Company's disclosures on transactions with related parties are contained in section IX. of the notes to the consolidated financial statements.

OTHER INFORMATION

The executive directors are responsible for the other information. The other information comprises the following non-audited parts of the group management report:

- the statement on corporate governance pursuant to § 289f HGB and § 315d HGB included in section "Corporate Governance Statement" of the group management report
- the corporate governance report pursuant to No. 3.10 of the German Corporate Governance Code
- the separate non-financial report pursuant to § 289b Abs. 3 HGB and § 315b Abs. 3 HGB

The other information comprises further the remaining parts of the annual report – excluding cross-references to external information – with the exception of the audited consolidated financial statements, the audited group management report and our auditor's report.

Our audit opinions on the consolidated financial statements and on the group management report do not cover the other information, and consequently we do not express an audit opinion or any other form of assurance conclusion thereon.

In connection with our audit, our responsibility is to read the other information and, in so doing, to consider whether the other information

- is materially inconsistent with the consolidated financial statements, with the group management report or our knowledge obtained in the audit, or
- otherwise appears to be materially misstated.

RESPONSIBILITIES OF THE EXECUTIVE DIRECTORS AND THE SUPERVISORY BOARD FOR THE CONSOLIDATED FINANCIAL STATEMENTS AND THE GROUP MANAGEMENT REPORT

The executive directors are responsible for the preparation of the consolidated financial statements that comply, in all material respects, with IFRSs as adopted by the EU and the additional requirements of German commercial law pursuant to § 315e Abs. 1 HGB and that the consolidated financial statements, in compliance with these requirements, give a true and fair view of the assets, liabilities, financial position, and financial performance of the Group. In addition the executive directors are responsible for such internal control as they have determined necessary to enable the preparation of consolidated financial statements that are free from material misstatement, whether due to fraud or error.

In preparing the consolidated financial statements, the executive directors are responsible for assessing the Group's ability to continue as a going concern. They also have the responsibility for disclosing, as applicable, matters related to going concern. In addition, they are responsible for financial reporting based on the going concern basis of accounting unless there is an intention to liquidate the Group or to cease operations, or there is no realistic alternative but to do so.

Furthermore, the executive directors are responsible for the preparation of the group management report that, as a whole, provides an appropriate view of the Group's position and is, in all material respects, consistent with the consolidated financial statements, complies with German legal requirements, and appropriately presents the opportunities and risks of future development. In addition, the executive directors are responsible for such arrangements and measures (systems) as they have considered necessary to enable the preparation of a group management report that is in accordance with the applicable German legal requirements, and to be able to provide sufficient appropriate evidence for the assertions in the group management report.

The supervisory board is responsible for overseeing the Group's financial reporting process for the preparation of the consolidated financial statements and of the group management report.

AUDITOR'S RESPONSIBILITIES FOR THE AUDIT OF THE CONSOLIDATED FINANCIAL STATEMENTS AND OF THE GROUP MANAGEMENT REPORT

Our objectives are to obtain reasonable assurance about whether the consolidated financial statements as a whole are free from material misstatement, whether due to fraud or error, and whether the group management report as a whole provides an appropriate view of the Group's position and, in all material respects, is consistent with the consolidated financial statements and the knowledge obtained in the audit, complies with the German legal requirements and appropriately presents the opportunities and risks of future development, as well as to issue an auditor's report that includes our audit opinions on the consolidated financial statements and on the group management report.

Reasonable assurance is a high level of assurance, but is not a guarantee that an audit conducted in accordance with § 317 HGB and the EU Audit Regulation and in compliance with German Generally Accepted Standards for Financial Statement Audits promulgated by the Institut der Wirtschaftsprüfer (IDW) will always detect a material misstatement. Misstatements can arise from fraud or error and are considered material if, individually or in the aggregate, they could reasonably be expected to influence the economic decisions of users taken on the basis of these consolidated financial statements and this group management report.

We exercise professional judgment and maintain professional skepticism throughout the audit. We also:

- Identify and assess the risks of material misstatement of the consolidated financial statements and of the group management report, whether due to fraud or error, design and perform audit procedures responsive to those risks, and obtain audit evidence that is sufficient and appropriate to provide a basis for our audit opinions. The risk of not detecting a material misstatement resulting from fraud is higher than for one resulting from error, as fraud may involve collusion, forgery, intentional omissions, misrepresentations, or the override of internal control.
- Obtain an understanding of internal control relevant to the audit of the consolidated financial statements and of arrangements and measures (systems) relevant to the audit of the group management report in order to design audit procedures that are appropriate in the circumstances, but not for the purpose of expressing an audit opinion on the effectiveness of these systems.
- Evaluate the appropriateness of accounting policies used by the executive directors and the reasonableness of estimates made by the executive directors and related disclosures.

- Conclude on the appropriateness of the executive directors' use of the going concern basis of accounting and, based on the audit evidence obtained, whether a material uncertainty exists related to events or conditions that may cast significant doubt on the Group's ability to continue as a going concern. If we conclude that a material uncertainty exists, we are required to draw attention in the auditor's report to the related disclosures in the consolidated financial statements and in the group management report or, if such disclosures are inadequate, to modify our respective audit opinions. Our conclusions are based on the audit evidence obtained up to the date of our auditor's report. However, future events or conditions may cause the Group to cease to be able to continue as a going concern.
- Evaluate the overall presentation, structure and content of the consolidated financial statements, including the disclosures, and whether the consolidated financial statements present the underlying transactions and events in a manner that the consolidated financial statements give a true and fair view of the assets, liabilities, financial position and financial performance of the Group in compliance with IFRSs as adopted by the EU and the additional requirements of German commercial law pursuant to § 315e Abs. 1 HGB.
- Obtain sufficient appropriate audit evidence regarding the financial information of the entities or business activities within the Group to express audit opinions on the consolidated financial statements and on the group management report. We are responsible for the direction, supervision and performance of the group audit. We remain solely responsible for our audit opinions.
- Evaluate the consistency of the group management report with the consolidated financial statements, its conformity with German law, and the view of the Group's position it provides.
- Perform audit procedures on the prospective information presented by the executive directors in the group management report. On the basis of sufficient appropriate audit evidence we evaluate, in particular, the significant assumptions used by the executive directors as a basis for the prospective information, and evaluate the proper derivation of the prospective information from these assumptions. We do not express a separate audit opinion on the prospective information and on the assumptions used as a basis. There is a substantial unavoidable risk that future events will differ materially from the prospective information.

We communicate with those charged with governance regarding, among other matters, the planned scope and timing of the audit and significant audit findings, including any significant deficiencies in internal control that we identify during our audit.

We also provide those charged with governance with a statement that we have complied with the relevant independence requirements, and communicate with them all relationships and other matters that may reasonably be thought to bear on our independence, and where applicable, the related safeguards.

From the matters communicated with those charged with governance, we determine those matters that were of most significance in the audit of the consolidated financial statements of the current period and are therefore the key audit matters. We describe these matters in our auditor's report unless law or regulation precludes public disclosure about the matter.

OTHER LEGAL AND REGULATORY REQUIREMENTS

FURTHER INFORMATION PURSUANT TO ARTICLE 10 OF THE EU AUDIT REGULATION

We were elected as group auditor by the annual general meeting on 10 May 2017. We were engaged by the supervisory board on 29 June 2017. We have been the group auditor of KSB SE & Co. KGaA, Frankenthal/Pfalz, without interruption since the financial year 2015.

We declare that the audit opinions expressed in this auditor's report are consistent with the additional report to the audit committee pursuant to Article 11 of the EU Audit Regulation (long-form audit report).

GERMAN PUBLIC AUDITOR RESPONSIBLE FOR THE ENGAGEMENT

The German Public Auditor responsible for the engagement is Dr. Ulrich Störk.

Mannheim, 21 March 2018

PricewaterhouseCoopers GmbH
Wirtschaftsprüfungsgesellschaft

Dr. Ulrich Störk
Wirtschaftsprüfer

ppa. Christina Pöpperl
Wirtschaftsprüferin

GLOSSARY

ABBREVIATIONS

ANSI

American National Standards Institute

API

American Petroleum Institute

API 610

New edition of a centrifugal pump code for the petrochemical industry

GDP

Gross domestic product

ISO 14001

International standard stipulating requirements for environmental management systems

IMF

International Monetary Fund

VDMA

Verband Deutscher Maschinen- und Anlagenbau e. V.
[German Engineering Federation]

KEY CORPORATE AND TECHNICAL TERMS

Additive manufacturing

Previously referred to as rapid prototyping; it describes a process which enables quick and cost-effective production of patterns, samples, prototypes, tools and final products.

Business Innovation Lab

A think tank where a KSB team develops future-proof business models for the age of digitalisation

CE marking

The CE marking documents that goods are in conformity with the health and safety requirements of the European Union.

Downstream

Activities in the oil and gas industry are categorised as upstream or downstream. The term "downstream" is used to describe the processing of crude oil into petroleum products.

GHG Protocol (Greenhouse Gas Protocol)

Standard for measuring CO₂ and other greenhouse gas emissions

IE5 synchronous reluctance motor

Highly energy-efficient motors whose specially designed rotor laminations guide the lines of magnetic flux. Rare earths are not required to manufacture these motors.

Installed Base

KSB sales channel for expanding business in the area of spare parts and support services

International Labour Organisation (ILO)

The specialised agency of the United Nations is responsible for

setting and implementing international labour and social standards.

Make in India

Indian government campaign to boost India's domestic economy

One Belt, One Road

Chinese government project to develop an intercontinental infrastructure network between China and countries in Asia, Europe and Africa

Rapid prototyping

See additive manufacturing

Retrofitting

Refurbishment of pumps as an alternative to buying new products

SAP C4C

Cloud-based IT solution for customer relationship management in Sales and Service

Stakeholders

Groups of persons that are directly or indirectly affected by the activities of a company; KSB's main stakeholders are our customers, suppliers, investors, employees and the public.

UN Global Compact

United Nations initiative for responsible company management based on ten universal principles

CONTACTS

EDITOR

KSB SE & Co. KGaA
 Johann-Klein-Str. 9
 67227 Frankenthal, Germany
 Tel. +49 6233 86-0
 Fax +49 6233 86-3401

ONLINE NEWS

You will find the latest news
 on the KSB Group at: www.ksb.com

Should you need additional information,
 please contact:

INVESTOR RELATIONS

Dieter Pott
 Tel. +49 6233 86-2615
 Fax +49 6233 86-3454
 E-mail: investor-relations@ksb.com

COMMUNICATIONS

Ullrich Bingenheimer
 Tel. +49 6233 86-2138
 Fax +49 6233 86-3456
 E-mail: ullrich.bingenheimer@ksb.com

CONCEPT AND DESIGN

KSB Communications, Frankenthal
 3st kommunikation, Mainz

PHOTOGRAPHY

KSB Image Library
 Robert Kwiatek, Frankenthal (p. 4/5, 6, 27, 36/37,
 40/41, 44/45, 48/49)
 Kenneth Dupuis, USA (p. 52/53)
 Kevin Brown, USA (title, p. 50)
 Habitat for Humanity (p. 22, top left)
 Egbert Schmitt, Halle (p. 27, top right)
 Vikas Shinde, India (p. 22, bottom right)
 Getty Images (p. 22, bottom left)

PRINTING

Ottweiler Druckerei und Verlag GmbH, Ottweiler



As a signatory to the United Nations Global Compact [UNGC](#), KSB is committed to endorsing the ten principles of the international community in the areas of human rights, labour standards, environmental protection and anti-corruption.

A print version of the KSB Group's Annual Report is additionally available in German. We also publish German and English versions online in PDF and HTML formats at <http://annualreport2017.ksb.com>



FINANCIAL CALENDAR

28 MARCH 2018

Financial press conference
10:00, Frankenthal, Germany

29 MARCH 2018

Invitation to Annual General Meeting

27 APRIL 2018

Interim report
January – March 2018

16 MAY 2018

Annual General Meeting
10:00, Frankenthal

14 AUGUST 2018

Half-year financial report
January – June 2018

8 NOVEMBER 2018

Interim report
January – September 2018

GLOBAL PRESENCE

Backed up by production and assembly sites around the world, as well as a tight-knit sales and service network, KSB staff are always close at hand.

- KSB production/assembly sites
- KSB sales/service sites

GLOBAL PRESENCE



EUROPE

Austria
Belarus
Belgium
Croatia
Czech Republic
Estonia
Finland
France
Germany
Hungary
Italy
Latvia
Luxembourg
Norway
Poland
Portugal
Russia
Serbia
Slovak Republic
Slovenia
Spain
Sweden
Switzerland
The Netherlands
Ukraine
United Kingdom

MIDDLE EAST / AFRICA

Algeria
Egypt
Ghana
Iran
Kenya
Morocco
Oman
Qatar
Saudi Arabia
South Africa
Turkey
United Arab Emirates
Zambia

ASIA / PACIFIC

Australia
China
India
Indonesia
Japan
Kazakhstan
Malaysia
New Zealand
Pakistan
Philippines
Singapore
South Korea
Taiwan
Thailand
Vietnam

AMERICAS

Argentina
Brazil
Chile
Canada
Columbia
Mexico
Peru
USA





KSB SE & Co. KGaA
67225 Frankenthal (Germany)
www.ksb.com